



American Opto Plus LED Corp.

L324L-UEC

3mm Red LED Lamp

DESCRIPTION

- Round Type
- 3mm Diameter
- Lens Color: Water Clear
- Without Flange
- Solder leads without standoffs

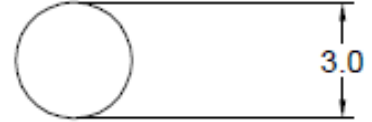

FEATURES

- Emitted Color: Red
- Technology: AlGaInP
- Viewing Angle: 44°

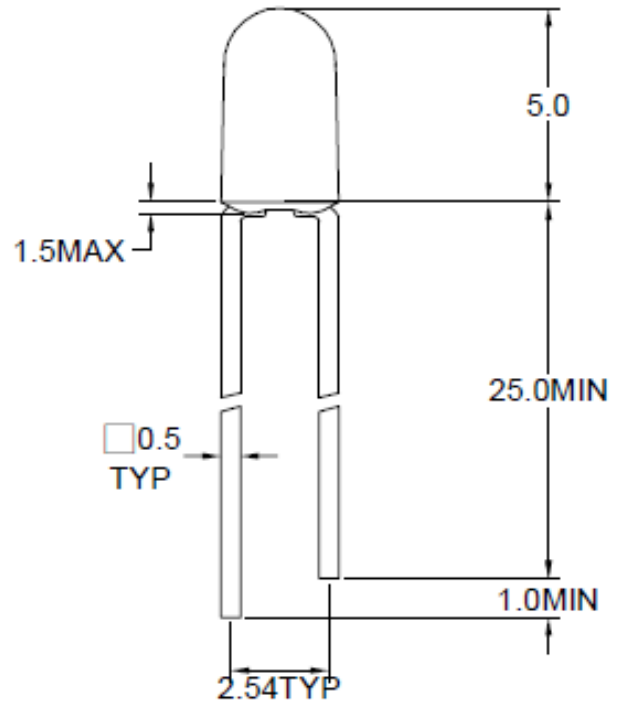

NOTES:

1. All dimensions are in millimeters tolerance is ± 0.25 mm unless otherwise noted;

Part Number	Material	Lens Color	
		Emitted	Lens
L324L-UEC	AlGaInP	Red	Water Clear



American Opto Plus LED Corp.

L324L-UEC

3mm Red LED Lamp

ABSOLUTE MAXIMUM RATINGS

(Ta=25°C)

Parameter	Symbol	Ratings	Unit
Forward Current	I _F	30	mA
Peak Forward Current Duty 1/10 @ 10KHz	I _{FP}	60	mA
Reverse Voltage	V _R	5	V
Power Dissipation	P _d	72	mW
Electrostatic Discharge	ESD	2000	V
Operating temperature range	T _{opr}	-40~+85	°C
Storage temperature range	T _{stg}	-40~+100	°C

OPTICAL-ELECTRICAL CHARACTERISTICS

(Ta=25°C)

Parameter	Symbol	Test Condition	Min	Typ	Max	Unit
Reverse Current	I _R	V _R =5V	--	--	10	μA
Forward Voltage	V _F	I _F =20mA	1.7	--	2.6	V
Luminous Intensity	I _v		4000	6200	--	mcd
Dominant Wavelength	P		--	625	--	nm
Spectral Halfwidth	Δλ		--	20	--	nm
Viewing Angle	2θ ½		--	44	--	deg

Note:

1. The forward voltage data did not include ±0.1V testing tolerance.
2. The luminous intensity data did not include ±15% testing tolerance.



American Opto Plus LED Corp.

L324L-UEC

3mm Red LED Lamp

LUMINOUS INTENSITY BIN CODE

Group	Luminous Intensity(mcd) at 10 mA	
	Min.	Max.
A28	4000	5000
A29	5000	6200
A30	6200	7700
A31	7700	9500
A32	9500	11500



American Opto Plus LED Corp.

L324L-UEC

3mm Red LED Lamp

TYPICAL ELECTRO-OPTICAL CHARACTERISTIC CURVE

Fig.1 Forward current vs. Forward Voltage

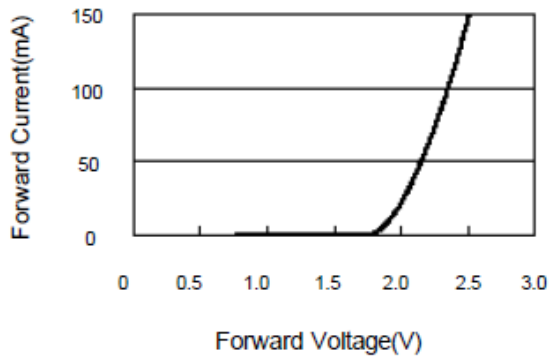

Fig.2 Luminous Intensity vs. Forward Current

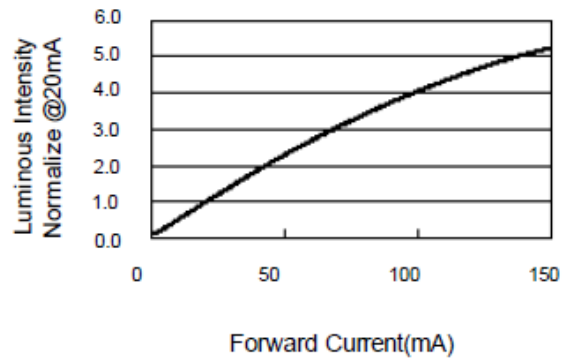

Fig.3 Forward Voltage vs. Temperature

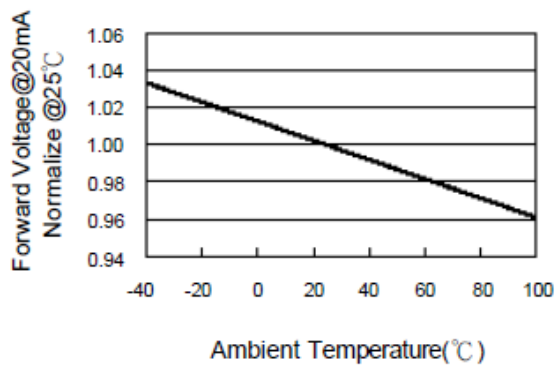

Fig.4 Luminous Intensity vs. Temperature

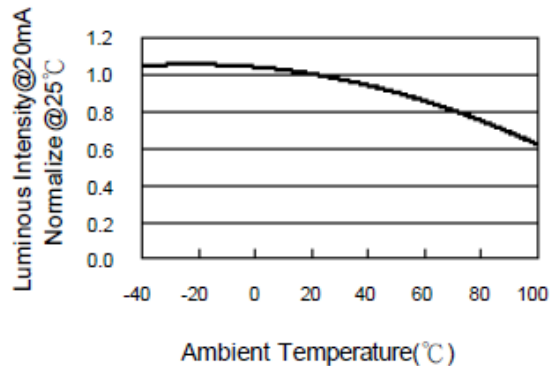

Fig.5 Relative Intensity vs. Wavelength

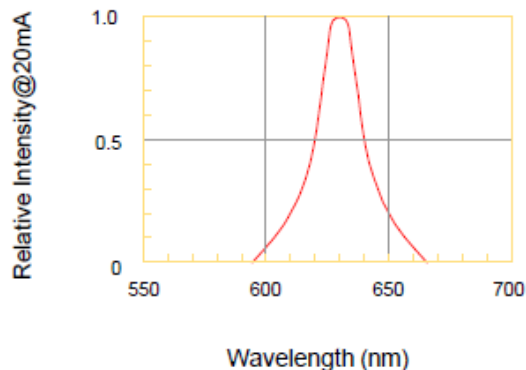
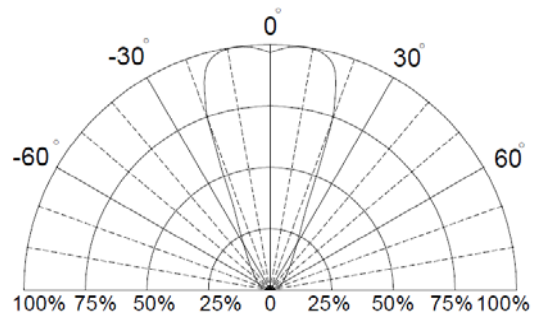

Fig.6 Directivity Radiation





American Opto Plus LED Corp.

L324L-UEC

3mm Red LED Lamp

SOLDERING CONDITION (Pb-Free)

1. Iron:

Soldering Iron: 30W Max

Temperature 350° C Max

Soldering Time: 3 Seconds Max (One time only)

Distance: 2mm Min (From solder joint to body)

2. Wave Soldering Profile

Dip Soldering

Preheat: 120° C Max

Preheat time: 60 seconds Max

Ramp-up

2° C/sec (max)

Ramp-Down: -5° C/sec (max)

Solder Bath: 260° C Max

Dipping Time: 3 seconds Max

Distance: 2mm Min (From solder joint to body)

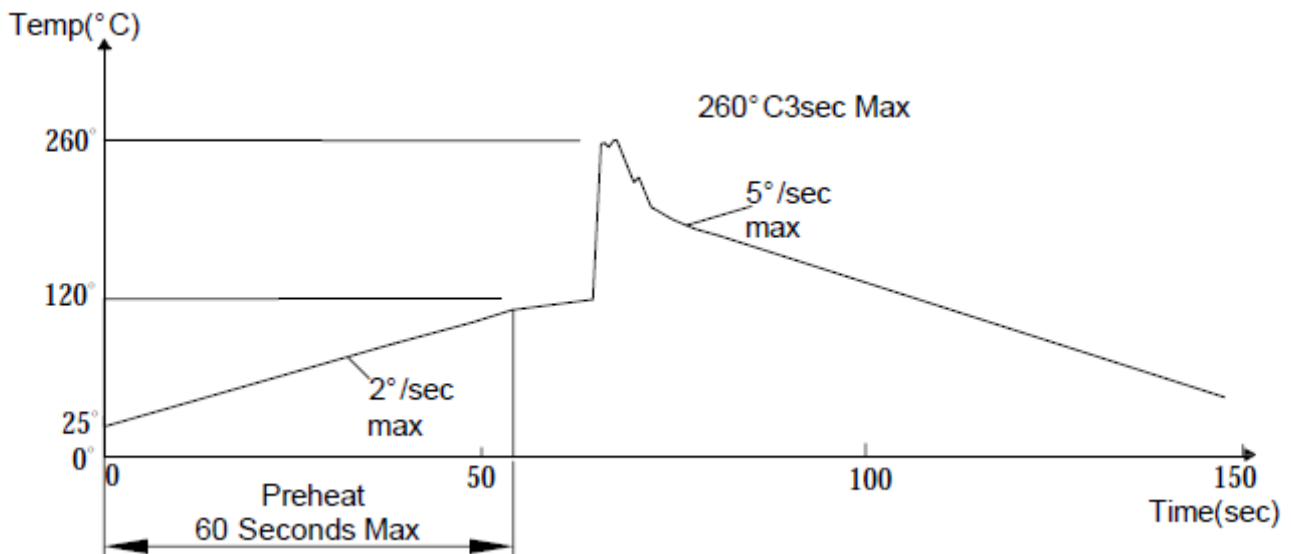

Note:

1. Wave solder should not be made more than one time.
2. You can just only select one of the soldering conditions as above.



American Opto Plus LED Corp.

L324L-UEC

3mm Red LED Lamp

RELIABILITY TEST

Test Item	Test Condition	Description	Reference Standard
Operating Life Test	1.Under Room Temperature 2.If=20mA 3.t=1000 hrs (-24hrs, +72hrs)	This test is conducted for the purpose of determining the resistance of a part in electrical and thermal stressed.	MIL-STD-750: 1026 MIL-STD-883: 1005 JIS C 7021: B-1
High Temperature Storage Test	1.Ta=105 °C±5°C 2.t=1000 hrs (-24hrs, +72hrs)	The purpose of this is the resistance of the device which is laid under condition of high temperature for hours.	MIL-STD-883:1008 JIS C 7021: B-10
Low Temperature Storage Test	1.Ta=-40 °C±5°C 2.t=1000 hrs (-24hrs, +72hrs)	The purpose of this is the resistance of the device which is laid under condition of low temperature for hours.	JIS C 7021: B-12
High Temperature High Humidity Test	1.Ta=65 °C±5°C 2.RH=90 %~95 % 3.t=240hrs ±2hrs	The purpose of this test is the resistance of the device under tropical for hours.	MIL-STD-202:103B JIS C 7021: B-11
Thermal Shock Test	1.Ta=105 °C±5°C & -40 °C±5°C (10min) (10min) 2.total 10 cycles	The purpose of this is the resistance of the device to sudden extreme changes in high and low temperature.	MIL-STD-202: 107D MIL-STD-750: 1051 MIL-STD-883: 1011
Solder Resistance Test	1.T.Sol=260 °C±5°C 2.Dwell time= 10 ±1sec.	This test intended to determine the thermal characteristic resistance of the device to sudden exposures at extreme changes in temperature when soldering the lead wire.	MIL-STD-202: 210A MIL-STD-750: 2031 JIS C 7021: A-1
Solderability Test	1.T.Sol=230 °C±5°C 2.Dwell time=5 ±1sec	This test intended to see soldering well performed or not.	MIL-STD-202: 208D MIL-STD-750: 2026 MIL-STD-883: 2003 JIS C 7021: A-2