



# American Opto Plus LED Corp.

## L944-UV415-2

4 x 4 x 2.4 mm Dome Lens Power UV LED

### PACKAGE OUTLINES

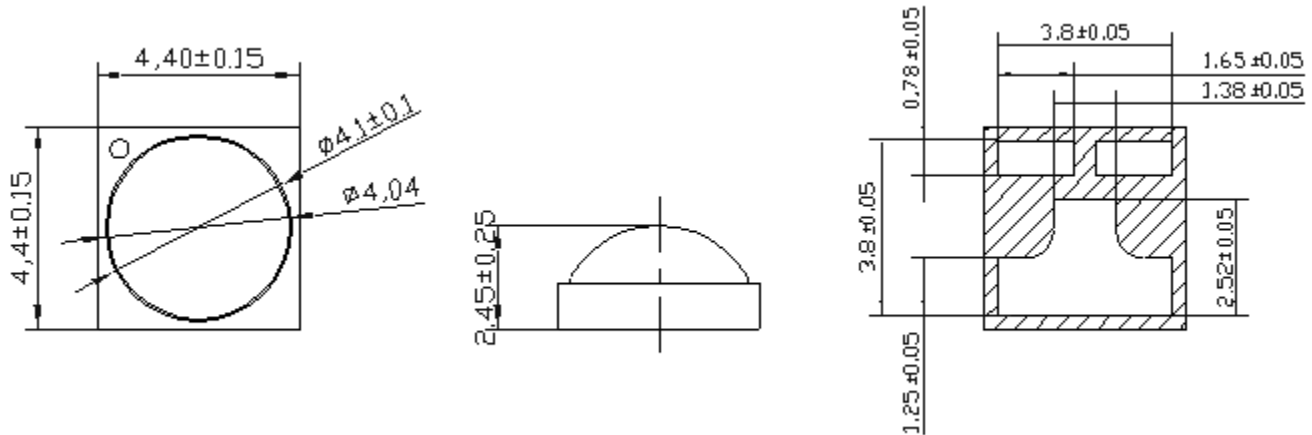

### PAD CONFIGURATION

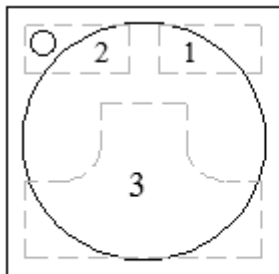

TOP

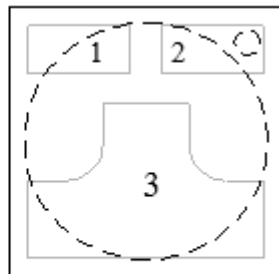

BOTTOM

Pad	Function
1	Cathode
2	Anode
3	Thermal

### FEATURES

- High Efficacy 3W UV LED
- All metal design Cu Substrate / Al Reflector with Quartz Glass Lens
- View Angle 120°
- Low Thermal Resistance
- InGaN Chip Inside
- Superior LED Protection



# American Opto Plus LED Corp.

## L944-UV415-2

4 x 4 x 2.4 mm Dome Lens Power UV LED

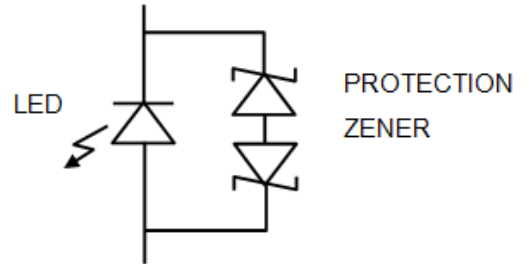
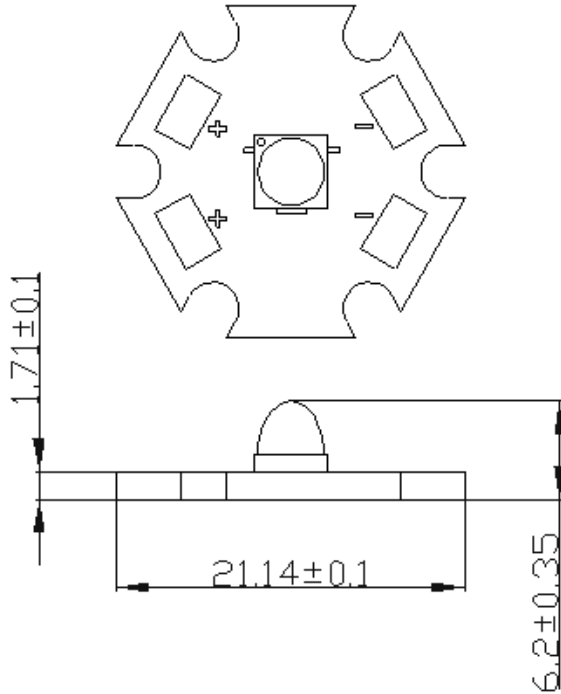

### RECOMMENDED SOLDER PATTERN

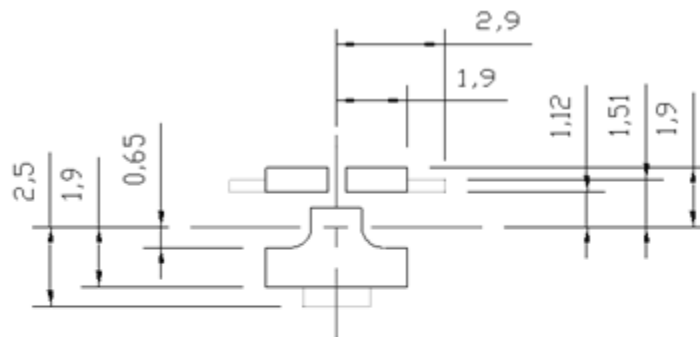

SOLDER MASK



COPPER LAYER





# American Opto Plus LED Corp.

## L944-UV415-2

4 x 4 x 2.4 mm Dome Lens Power UV LED

### ABSOLUTE MAXIMUM RATINGS

(Ta=25°C)

Parameter	Symbol	Value	Unit
Forward Current	I <sub>F</sub>	700	mA
Power Dissipation	P	3	W
Peak Pulse Current (1/10 Duty Cycle, 400msec Pulse Width)	I <sub>FP</sub>	1000	mA
Thermal Resistance, Junction-Case	R <sub>th, J-C1</sub>	5	°C/W
LED Junction Temperature	T <sub>J</sub>	125	°C
Operating Temperature Range	T <sub>OPR</sub>	-40~+80	°C
Storage Temperature Range	T <sub>STG</sub>	-40~+120	°C
Soldering Condition	T <sub>SOL</sub>	260°C for 5 seconds	

### OPTICAL-ELECTRO CHARACTERISTICS

(Ta=25°C)

Parameter	Test Condition	Symbol	Min	Typ	Max	Unit
Forward Voltage	I <sub>F</sub> =700mA	V <sub>F</sub>	3.03	3.8	4.47	V
Radiant Flux		Φ <sub>E</sub>	500	750	--	mW
Peak Wavelength		λ <sub>P</sub>	--	415	--	Nm
Spectra Half-Width		Δλ	--	15	--	Nm



# American Opto Plus LED Corp.

## L944-UV415-2

4 x 4 x 2.4 mm Dome Lens Power UV LED

### BIN CODE LIST FOR REFERENCE

Item	Bin Code	Symbol	Condition	Min	Max	Unit
Forward Voltage	H	$V_F$	$I_F=700\text{mA}$	3.03	3.27	V
	J			3.27	3.51	
	K			3.51	3.75	
	L			3.75	3.99	
	M			3.99	4.23	
	N			4.23	4.47	
Radiant Flux	C	$\Phi_E$	$I_F=700\text{mA}$	275	350	mW
	D			350	425	
	E			425	500	
	F			500	600	

#### Notes:

1. Forward Voltage measurement allowance is  $\pm 0.1\text{V}$ .
2. Radiant Flux measurement allowance is  $\pm 10\%$ .
3. Wavelength measurement allowance is  $\pm 2\text{nm}$ .



# American Opto Plus LED Corp.

## L944-UV415-2

4 x 4 x 2.4 mm Dome Lens Power UV LED

### CHARACTERISTIC DIAGRAM

Fig. Forward Current vs. Forward Voltage

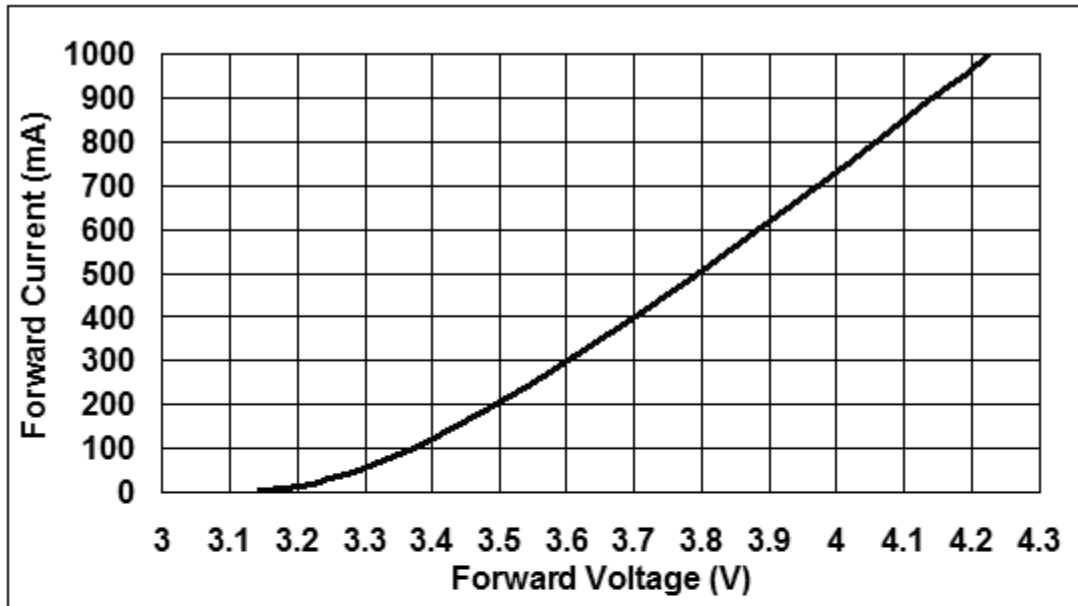
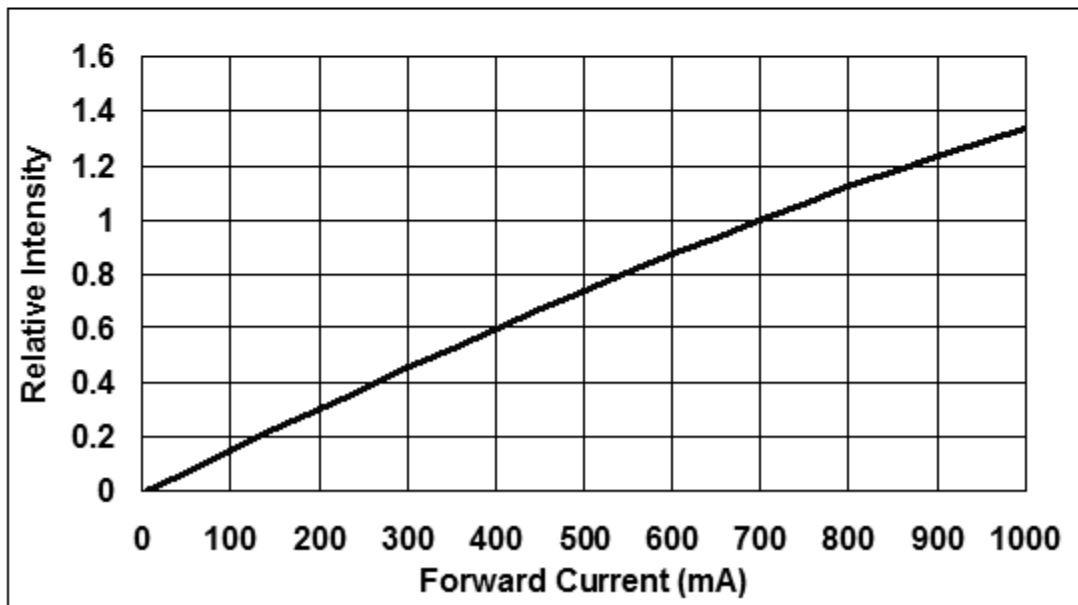

Fig. Relative Intensity vs. Forward Current





# American Opto Plus LED Corp.

## L944-UV415-2

4 x 4 x 2.4 mm Dome Lens Power UV LED

Fig. Typical Relative Intensity vs. Wavelength

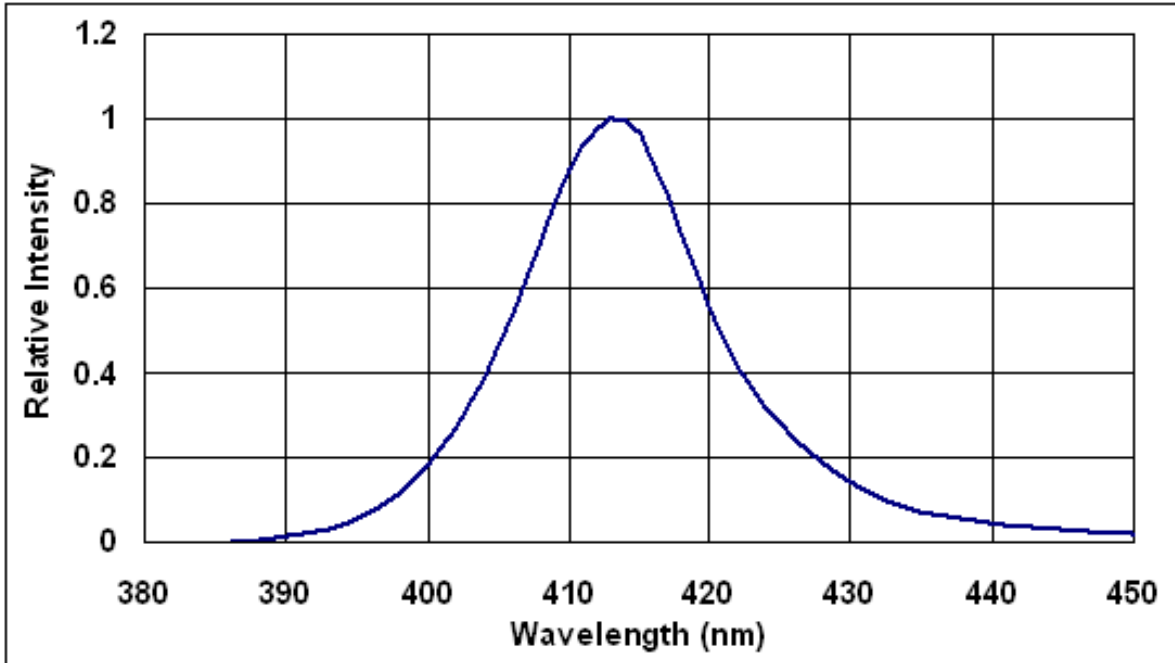
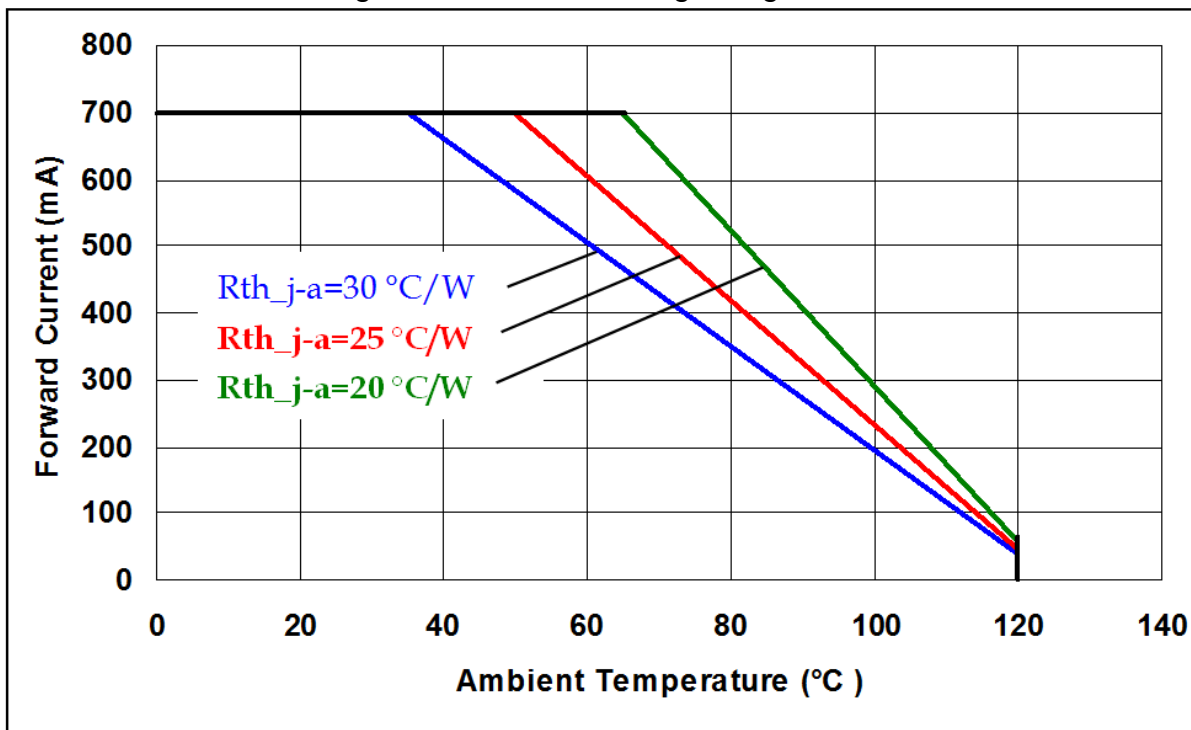

Fig. Forward Current Degrading Curve





# American Opto Plus LED Corp.

## L944-UV415-2

4 x 4 x 2.4 mm Dome Lens Power UV LED

Fig. Relative Intensity vs. Case Temperature

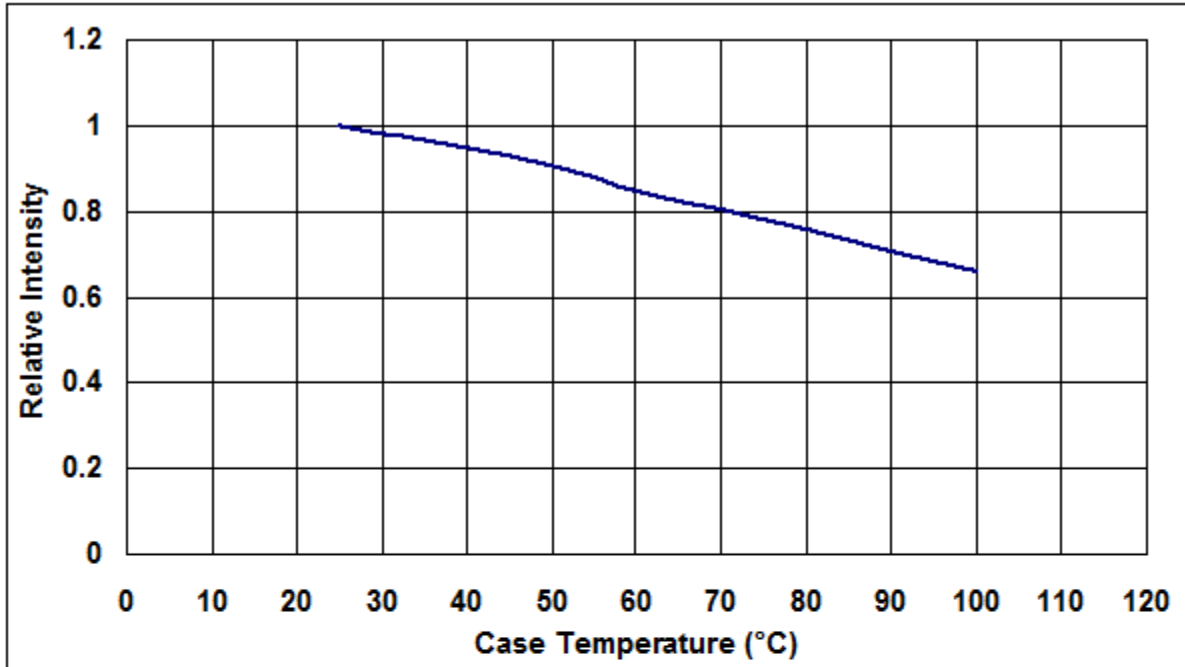
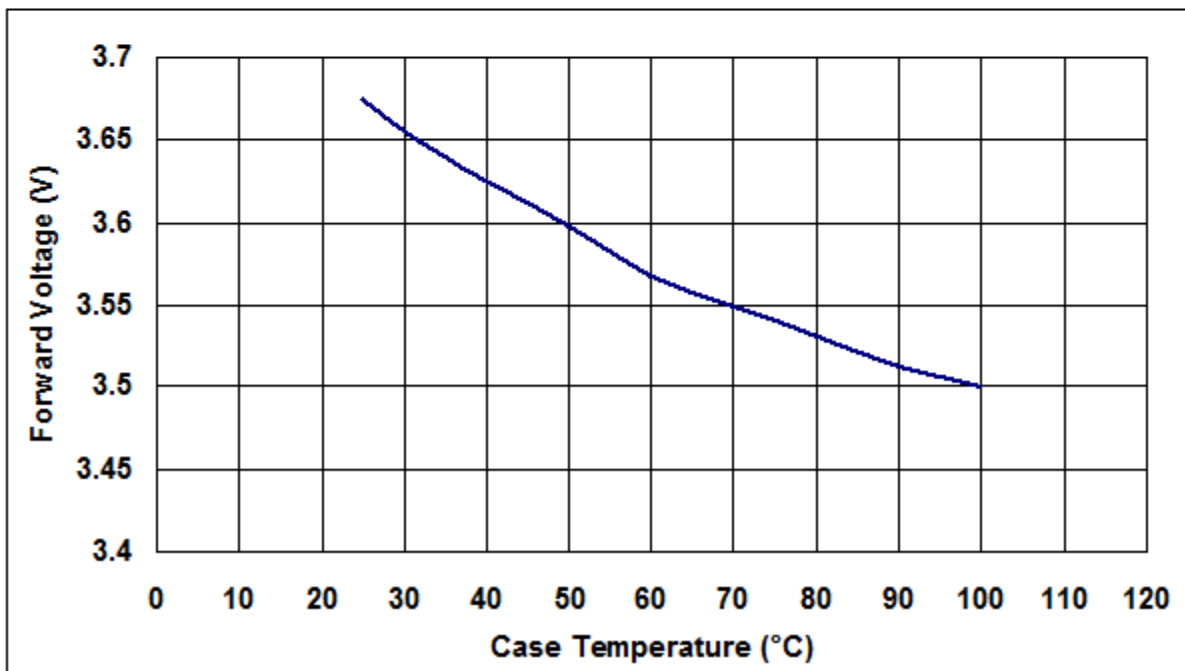

Fig. Forward Voltage vs. Case Temperature





# American Opto Plus LED Corp.

## L944-UV415-2

4 x 4 x 2.4 mm Dome Lens Power UV LED

Fig. Peak Wavelength shift vs. Case Temperature

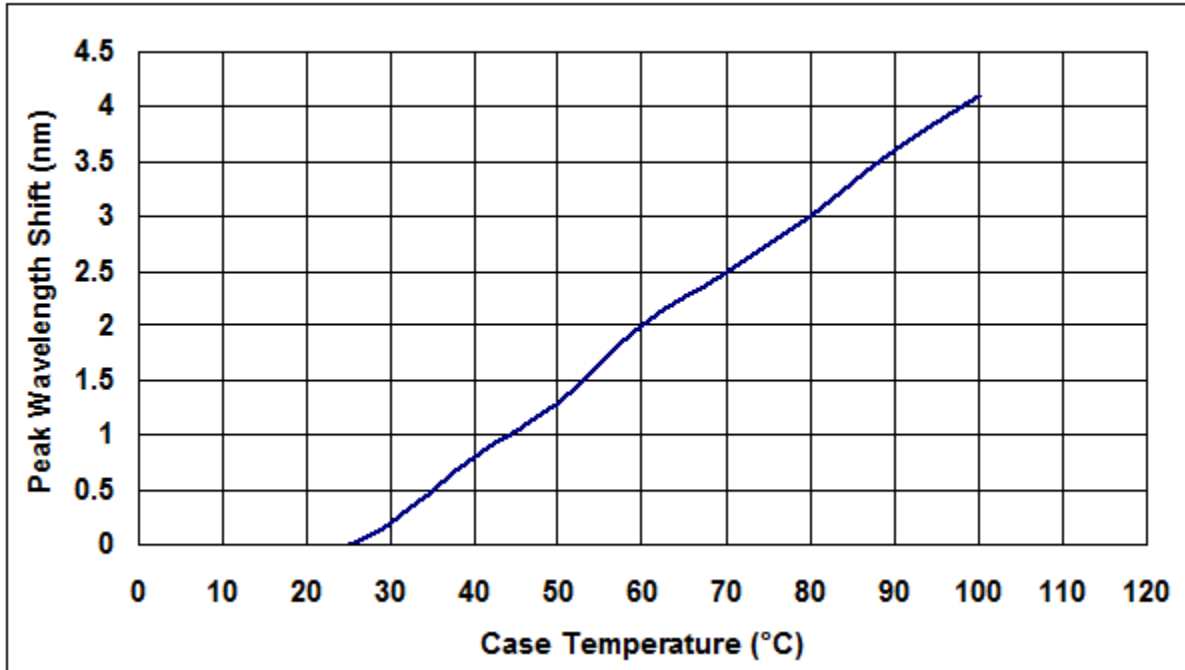

Typical Spatial Radiation Pattern

Fig. (120° Lens) Typical Representative Spatial Radiation Pattern

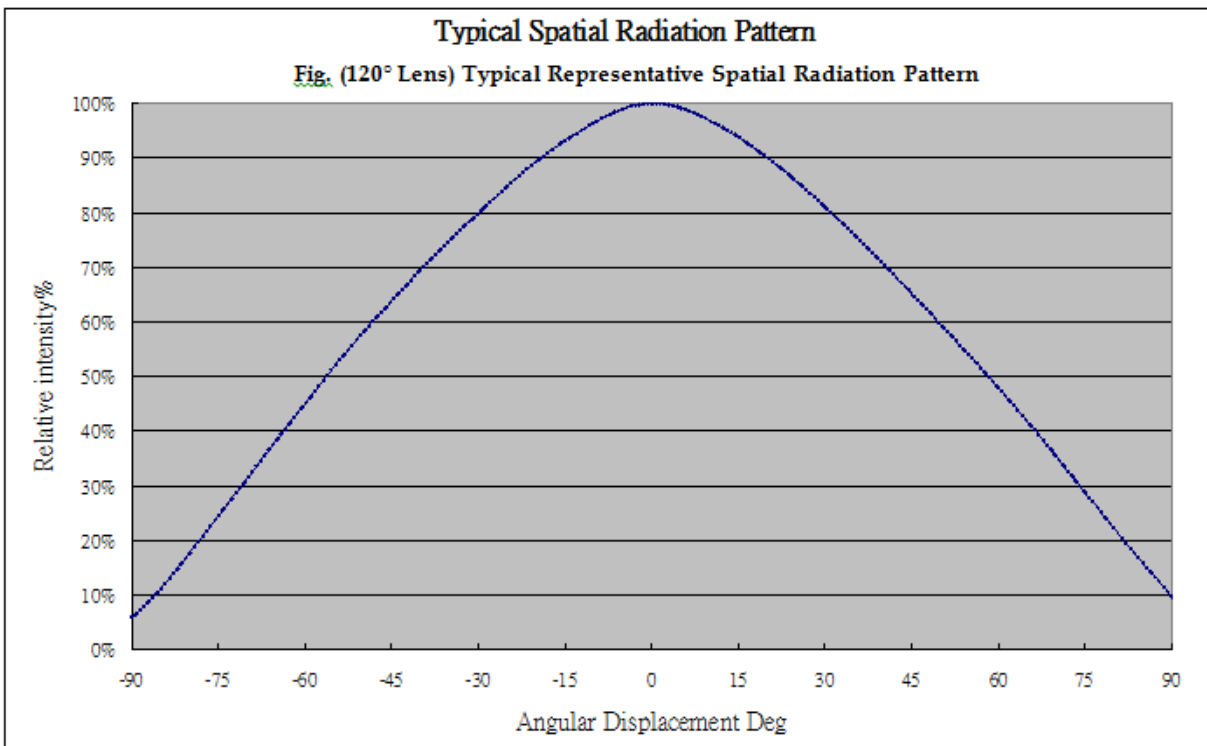





# American Opto Plus LED Corp.

## L944-UV415-2

4 x 4 x 2.4 mm Dome Lens Power UV LED

### REFLOW SOLDERING CHARACTERISTICS

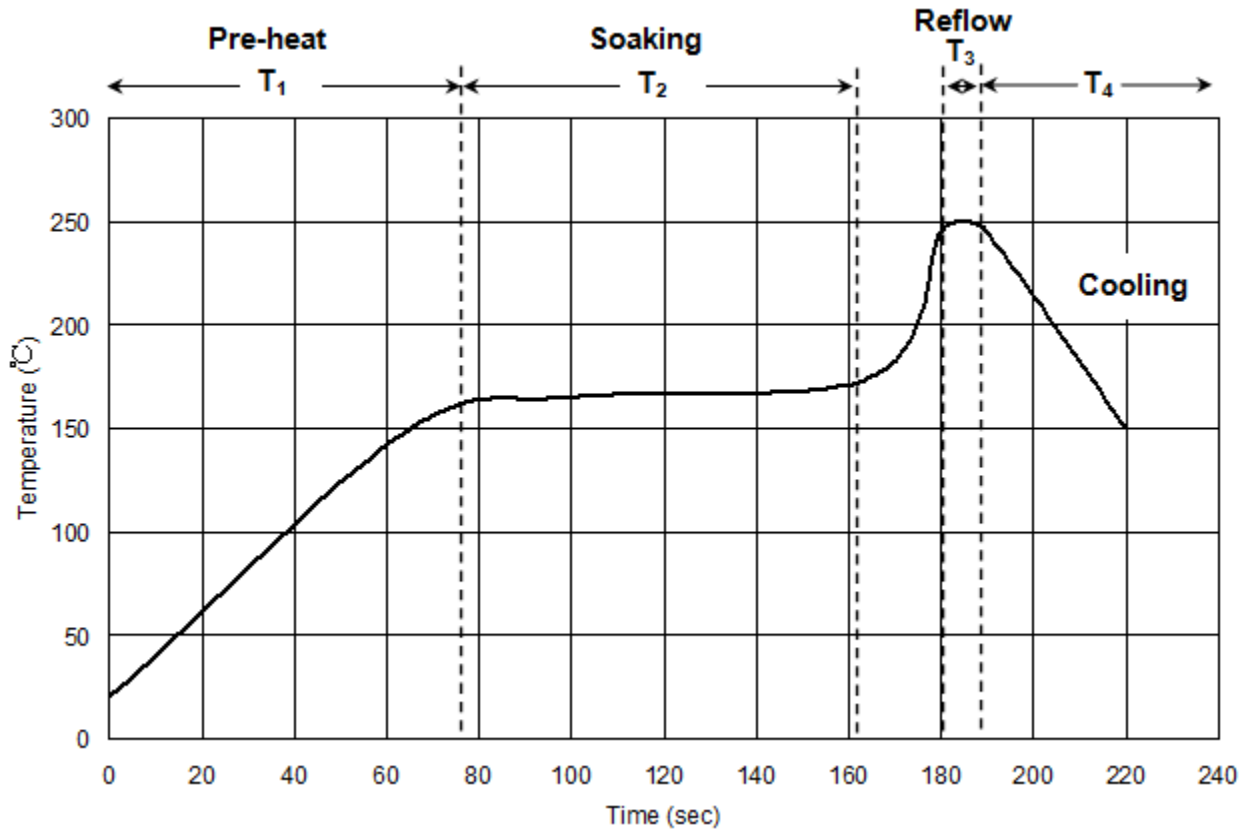

T1	Ramp up rate	1.0~3.0 °C/sec
	Pre-heat time	50~80 sec
T2	Soaking temperature	155~185 °C
	Dwell time during soaking	60~120 sec
T3	Reflow temperature	240~250 °C
	Reflow time	Max 10 sec
T4	Ramp up rate during reflow	1.2~2.3 °C/sec
	Cooling	1.0~6.0 °C.sec

Note: suggest using Sn96Ag3Cu0.5 lead free solder



# American Opto Plus LED Corp.

## L944-UV415-2

4 x 4 x 2.4 mm Dome Lens Power UV LED

### RELIABILITY TEST

Classification	Test Item	Test conditions	Reference Standard
Endurance Test	Operation Life	$I_f = 60\text{mA}/120\text{mA}(\text{H}28)$ , $350\text{mA}/700\text{mA}(\text{H}40/\text{H}44/\text{H}99)$ $T_a = 25^\circ\text{C}$ Test Duration = 1000hrs	MIL-STD-750: 1026 MIL-STD-883: 1005 JIS C 7021: B-1
	High Temperature High Humidity Storage	$I_f = 60\text{mA}/120\text{mA}(\text{H}28)$ , $350\text{mA}/700\text{mA}(\text{H}40/\text{H}44/\text{H}99)$ $T_a = 85\pm 5^\circ\text{C}$ RH = 85±5% Test Duration = 1000hrs	MIL-STD-202: 103B JIS C 7021: B-11
	High Temperature Storage	$T_a = 105\pm 5^\circ\text{C}$ Test Duration = 1000hrs	MIL-STD-202: 1008 JIS C 7021: B10
	Low Temperature Storage	$T_a = -40\pm 5^\circ\text{C}$ Test Duration = 1000hrs	JIS C 7021: B-12
Environmental Test	Temperature Cycling	$-40^\circ\text{C} \sim 25^\circ\text{C} \sim 105^\circ\text{C} \sim 25^\circ\text{C}$ 30min 5min 30min 5min Test Duration = 10 cycle	MIL-STD-202: 107D MIL-STD-750: 1051 MIL-STD-883: 1010 JIS C 7021: A-4
	Thermal Shock	$-55\pm 5^\circ\text{C} \sim 105\pm 5^\circ\text{C}$ 30min 30min Test Duration = 10 cycle	MIL-STD-202: 107D MIL-STD-750: 1051 MIL-STD-883: 1011
	Solder Resistance	$T_{\text{sol}} = 260\pm 5^\circ\text{C}$ Dwell Time = 10sec	MIL-STD-202: 210A MIL-STD-750: 2031 JIS C 7021: A-1
Measuring Items	Symbol	Measuring Conditions	Failure Criteria
Forward voltage	$V_F$	$I_f = 60\text{mA}/120\text{mA}(\text{H}28)$ , $350\text{mA}/700\text{mA}(\text{H}40/\text{H}44/\text{H}99)$	$V_F$ shift > 10%
Luminous	$I_v\%$	$I_f = 60\text{mA}/120\text{mA}(\text{H}28)$ , $350\text{mA}/700\text{mA}(\text{H}40/\text{H}44/\text{H}99)$	$I_v\%$ shift > 10%



# American Opto Plus LED Corp.

## L944-UV415-2

4 x 4 x 2.4 mm Dome Lens Power UV LED

### SHIPPING PACKAGE DIMENSIONS

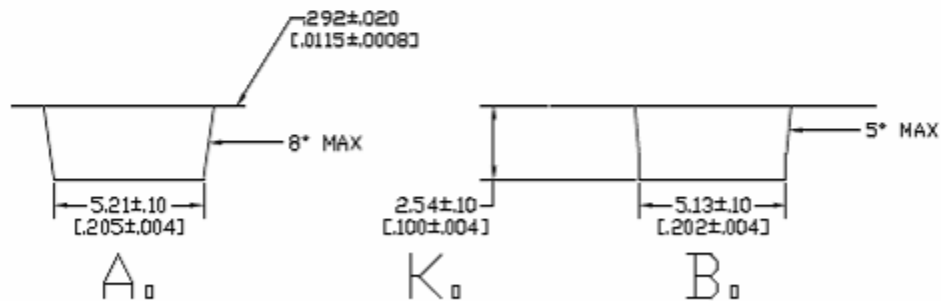
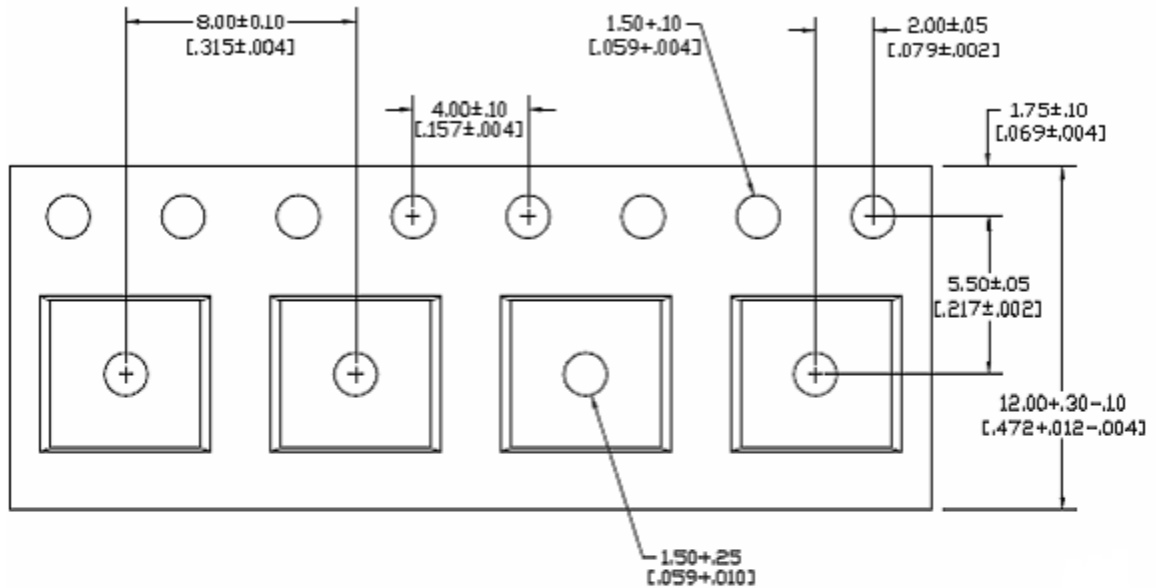

MM  
[INCH]

#### Lens Type

#### 120 Degree Lens Type:

- Moisture Proof Bag
- 1 Reel/Bag
- 800 Max/Reel



# American Opto Plus LED Corp.

## L944-UV415-2

4 x 4 x 2.4 mm Dome Lens Power UV LED

### REEL DIMENSION

