



# American Opto Plus LED Corp.

## L999-UV405

9.0 x 9.0 x 5.3 mm Dome Lens UV SMD LED

### PACKAGE OUTLINES

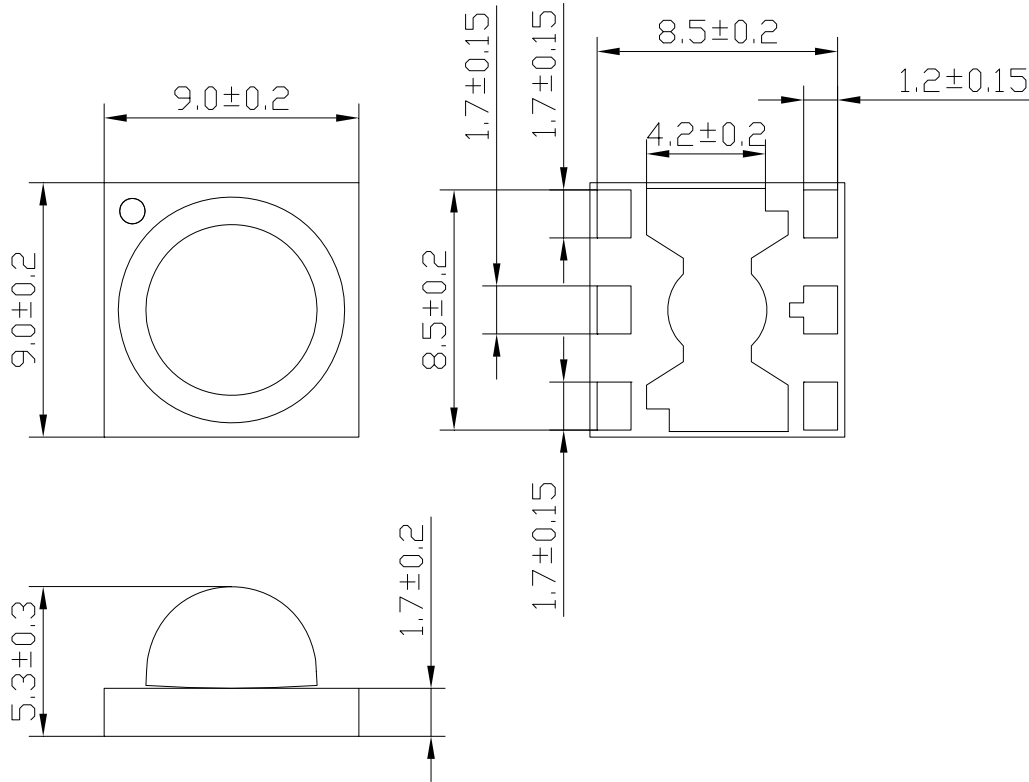

### PAD CONFIGURATION

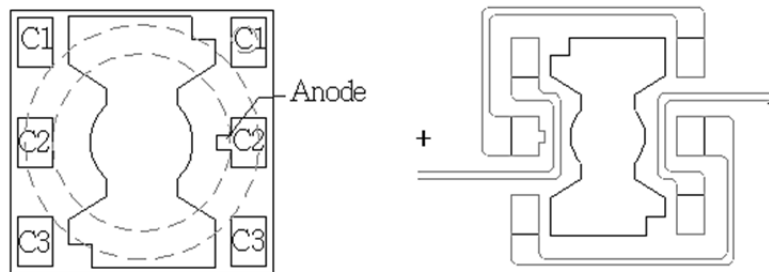

Part Number	Chip Material	Peak Wavelength	Viewing Angle
L990-UV405	InGaN	405nm	70°



# American Opto Plus LED Corp.

## L999-UV405

9.0 x 9.0 x 5.3 mm Dome Lens UV SMD LED

### ABSOLUTE MAXIMUM RATINGS

(Ta=25°C)

Parameter	Symbol	Value	Unit
Forward Current	I <sub>F</sub>	700	mA
Forward Pulse Current*	I <sub>FP</sub>	1000	mA
Power Dissipation	P <sub>D</sub>	9	W
Thermal Resistance, Junction-Case	R <sub>th, J-C1</sub>	3.3	°C/W
LED Junction Temperature	T <sub>J</sub>	125	°C
Operating Temperature Range	T <sub>OPR</sub>	-40~+80	°C
Storage Temperature Range	T <sub>STG</sub>	-40~+120	°C
Soldering Condition	T <sub>SOL</sub>	260°C for 5 seconds	

\*Note: Forward Pulse Current=1/10 Duty Cycle, 400msec Pulse Width

### OPTICAL-ELECTRO CHARACTERISTICS

(Ta=25°C)

Parameter	Test Condition	Symbol	Min	Typ	Max	Unit
Forward Voltage	I <sub>F</sub> =700mA	V <sub>F</sub>	--	11.2	--	V
Radiant Flux		Φ <sub>e</sub>	1050	1650	--	mW
Peak Wavelength		λ <sub>P</sub>	--	405	--	Nm
Spectra Half-Width		Δλ	--	15	--	Nm



# American Opto Plus LED Corp.

## L999-UV405

9.0 x 9.0 x 5.3 mm Dome Lens UV SMD LED

### CHARACTERISTIC DIAGRAM

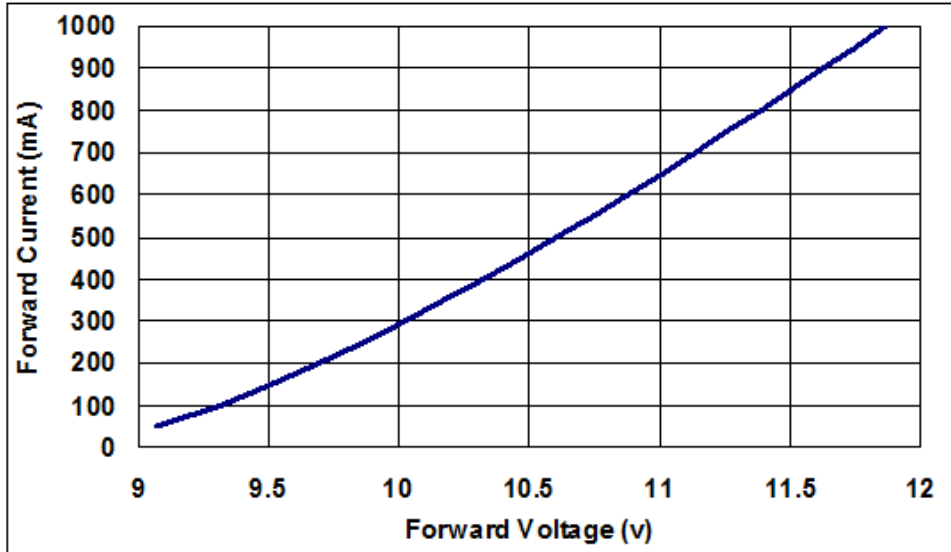

Fig. Forward Current vs. Forward Voltage

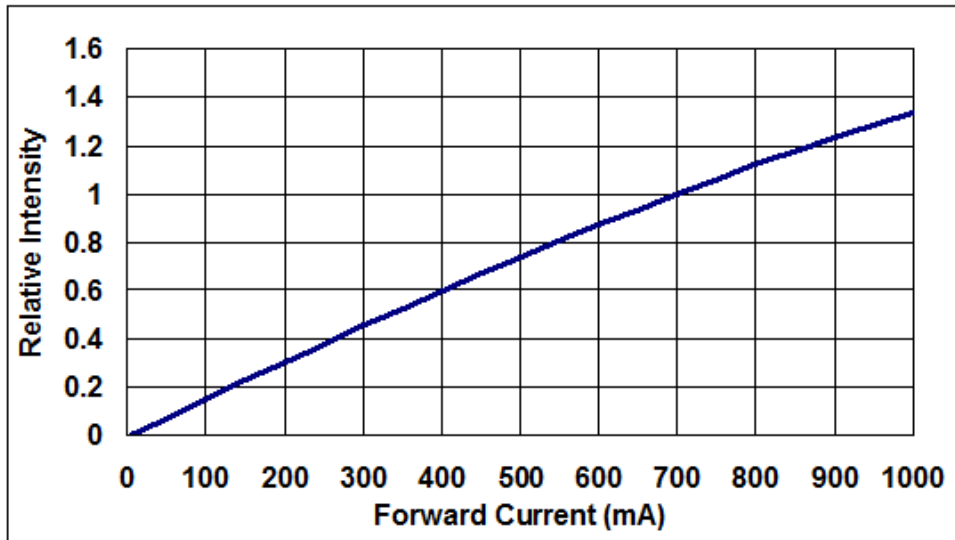

Fig. Relative Intensity vs. Forward Current



# American Opto Plus LED Corp.

## L999-UV405

9.0 x 9.0 x 5.3 mm Dome Lens UV SMD LED

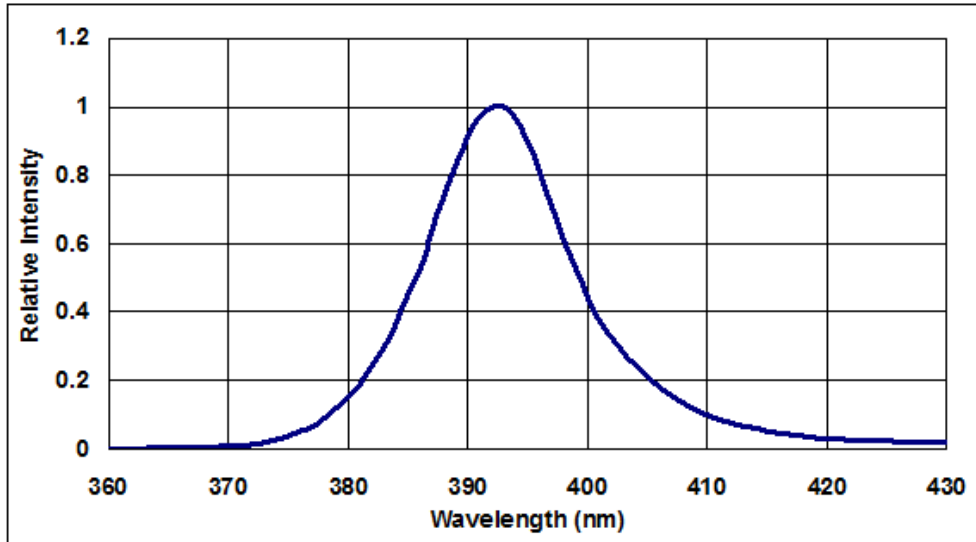

Fig. Typical Relative Intensity vs. wavelength

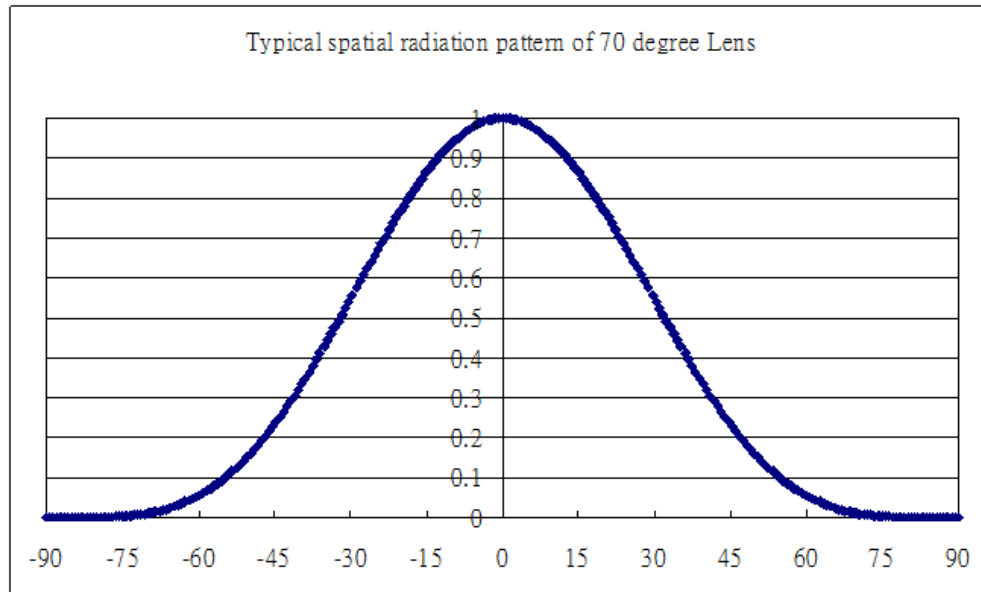

Fig. (70° Lens) Typical Representative Spatial Radiation Pattern



# American Opto Plus LED Corp.

## L999-UV405

9.0 x 9.0 x 5.3 mm Dome Lens UV SMD LED

### REFLOW SOLDERING CHARACTERISTICS

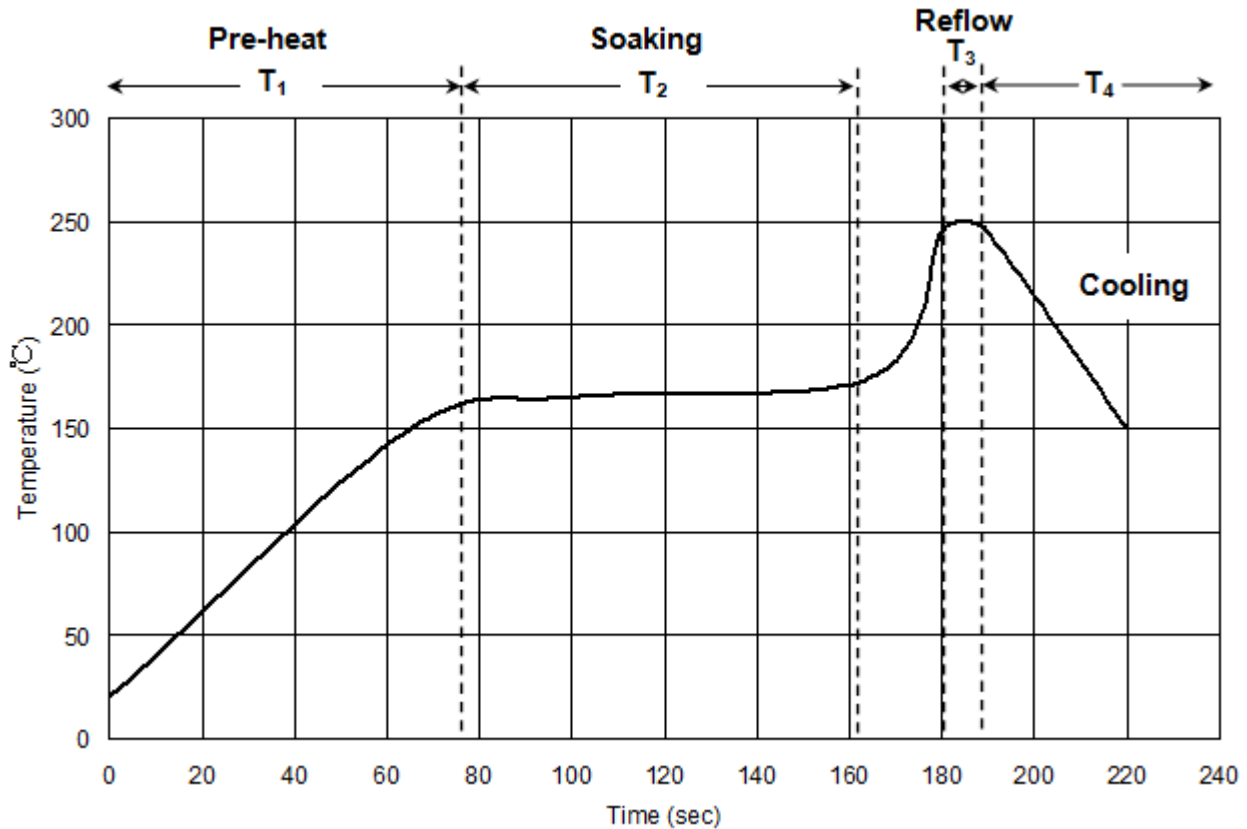

T1	Ramp up rate	1.0~3.0 °C/sec
	Pre-heat time	50~80 sec
T2	Soaking temperature	155~185 °C
	Dwell time during soaking	60~120 sec
T3	Reflow temperature	240~250 °C
	Reflow time	Max 10 sec
T4	Ramp up rate during reflow	1.2~2.3 °C/sec
	Cooling	1.0~6.0 °C.sec

Note: suggest using Sn96Ag3Cu0.5 lead free solder





# American Opto Plus LED Corp.

## L999-UV405

9.0 x 9.0 x 5.3 mm Dome Lens UV SMD LED

### RELIABILITY TEST

Classification	Test Item	Test conditions	Reference Standard
Endurance Test	Operation Life	$I_f = 700\text{mA}$ $T_a = 25^\circ\text{C}$ Test Duration = 1000hrs	MIL-STD-750: 1026 MIL-STD-883: 1005 JIS C 7021: B-1
	High Temperature High Humidity Storage	$I_f = 700\text{mA}$ $T_a = 85 \pm 5^\circ\text{C}$ RH = 85 ± 5% Test Duration = 1000hrs	MIL-STD-202: 103B JIS C 7021: B-11
	High Temperature Storage	$T_a = 105 \pm 5^\circ\text{C}$ Test Duration = 1000hrs	MIL-STD-202: 1008 JIS C 7021: B10
	Low Temperature Storage	$T_a = -40 \pm 5^\circ\text{C}$ Test Duration = 1000hrs	JIS C 7021: B-12
Environmental Test	Temperature Cycling	$-40^\circ\text{C} \sim 25^\circ\text{C} \sim 105^\circ\text{C} \sim 25^\circ\text{C}$ 30min 5min 30min 5min Test Duration = 10 cycle	MIL-STD-202: 107D MIL-STD-750: 1051 MIL-STD-883: 1010 JIS C 7021: A-4
	Thermal Shock	$-55 \pm 5^\circ\text{C} \sim 105 \pm 5^\circ\text{C}$ 30min 30min Test Duration = 10 cycle	MIL-STD-202: 107D MIL-STD-750: 1051 MIL-STD-883: 1011
	Solder Resistance	$T_{sol} = 260 \pm 5^\circ\text{C}$ Dwell Time = 10sec	MIL-STD-202: 210A MIL-STD-750: 2031 JIS C 7021: A-1
Measuring Items	Symbol	Measuring Conditions	Failure Criteria
Forward voltage	$V_f$	$I_f = 700\text{mA}$	$V_f$ shift > 10%
Luminous	$I_v\%$	$I_f = 700\text{mA}$	$I_v\%$ shift > 10%