



American Opto Plus LED

C/A561E-5 G/W

0.56" Single Digit Seven Segment Display

- ❖ 0.56inch (14.22 mm) height
- ❖ Low power consumption
- ❖ RoHS Compliance
- ❖ Case mold type

Package Dimensions

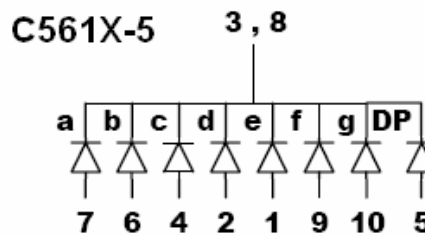
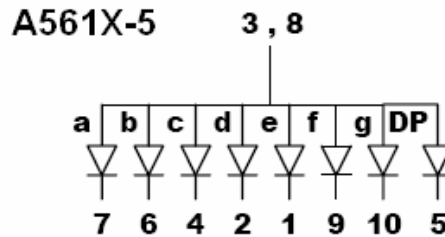
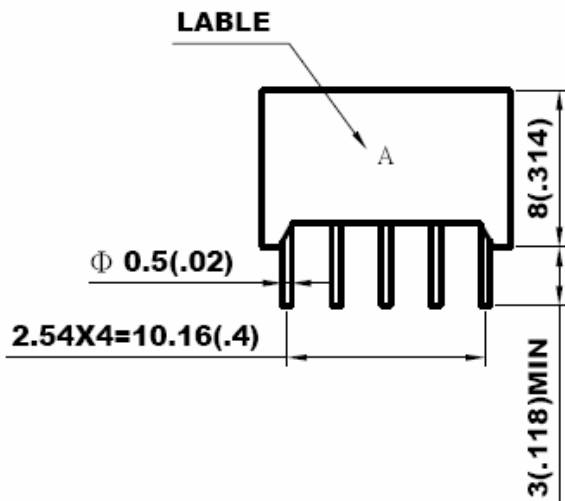
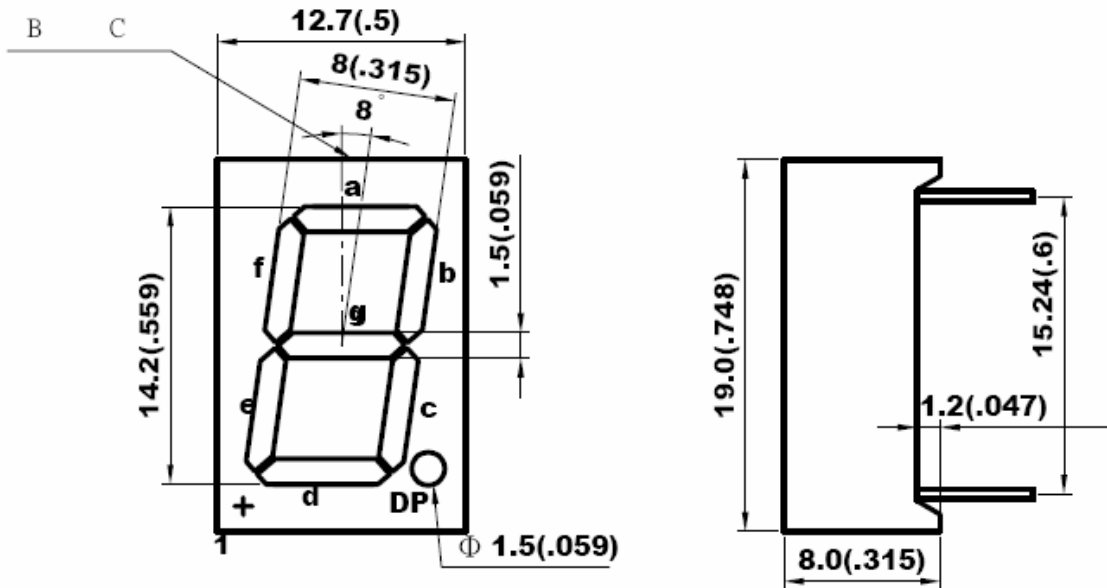

- Notes: 1. Label Notes: A: Part Number B: Date C: Bin Code
2. All dimensions are in millimeters (inches)
3. Tolerance is $\pm 0.25\text{mm}$ (0.01") unless otherwise specified



American Opto Plus LED

C/A561E-5 G/W

0.56" Single Digit Seven Segment Display

- ❖ 0.56inch (14.22 mm) height
- ❖ Low power consumption
- ❖ RoHS Compliance
- ❖ Case mold type

DEVICE SELECTION GUIDE

Part Number	Chip		Face / Segment
	Material	Emitted Color	
C/A 561E-5 G/W	AlGaAs	Orange-Red	Gray / White

ABSOLUTE MAXIMUM RATINGS

(Ta=25°C)

Parameter	Symbol	Max Rating	Unit
Power Dissipation per segment	PAD	75	mW
Peak Current per segment (1/10 Duty Cycle @1KHz)	IAF	100	mA
Continuous Forward Current per segment	IPF	30	mA
Reverse Voltage	VR	5.0	V
Operating Temperature Range	TOPR	-40~+85	°C
Storage Temperature Range	TSTG	-40~+85	°C

Solder temperature 1.6 mm from body for 3 seconds at 260°C

OPTICAL-ELECTRICAL CHARACTERISTICS

Parameter	Symbol	Test Condition	Min	Typ	Max	Unit
Ave. Luminous Intensity	IV	IF = 10mA	3000	8000		μcd
Forward Voltage/segment	VF	IF = 10mA		1.85	2.50	V
Reverse Current/segment	IR	VR = 5V			10	uA
Spectrum Line Half-Width	Δλ	IF = 10mA		45		nm
Dominant Wavelength	λd	IF = 10mA		620		nm
Peak Wavelength	λp	IF = 10mA		630		nm



American Opto Plus LED

C/A561E-5 G/W

0.56" Single Digit Seven Segment Display

- ❖ 0.56inch (14.22 mm) height
- ❖ Low power consumption
- ❖ RoHS Compliance
- ❖ Case mold type

TYPICAL ELECTRO-OPTICAL CHARACTERISTIC CURVES: ORANGE-RED (E)

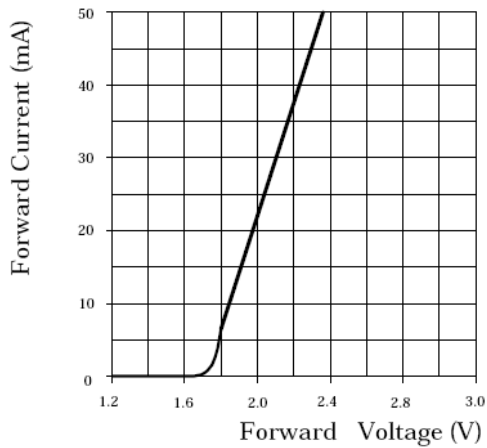

Forward Current Vs.
Forward Voltage

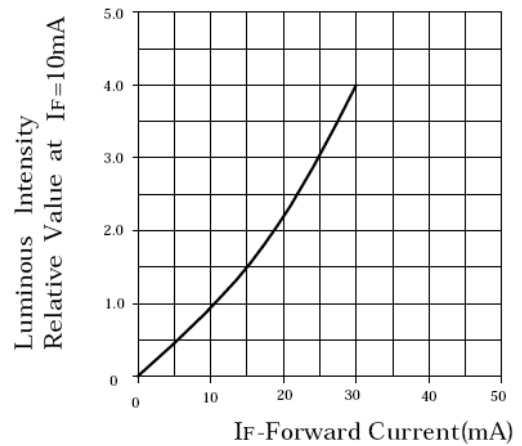

Luminous Intensity Vs.
Forward Current

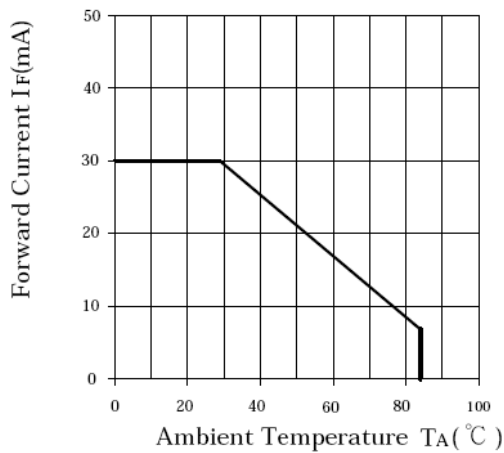

Forward Current
Derating Curve

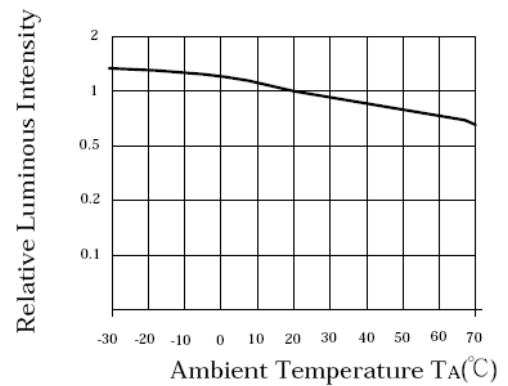

Luminous Intensity Vs.
Ambient Temperature



American Opto Plus LED
C/A561E-5 G/W
0.56" Single Digit Seven Segment Display

- ❖ 0.56inch (14.22 mm) height
- ❖ Low power consumption
- ❖ RoHS Compliance
- ❖ Case mold type

WAVE SOLDERING

SOLDERING INSTRUCTIONS						
TYPES	DIP AND WAVE SOLDERING			IRON SOLDERING(WITH 1.5mm IRON TIP)		
	TEMPERATURE OF THE SOLDERING BATH	MAXIMUM SOLDERING TIME	DISTANCE FROM SOLDER JOINT TO CASE	TEMPERATURE OF SOLDERING IRON	MAXIMUM SOLDERING TIME	DISTANCE FROM SOLDER JOINT TO CASE
LEDS	$\leq 260^{\circ}\text{C}$	3S	$>2\text{mm}$	$\leq 295^{\circ}\text{C}$	3S	$>2\text{mm}$
	$\leq 260^{\circ}\text{C}$	5S	$>4\text{mm}$	$\leq 295^{\circ}\text{C}$	5S	$>4\text{mm}$
DISPLAYS	$\leq 260^{\circ}\text{C}$	3S	$>2\text{mm}$	$\leq 295^{\circ}\text{C}$	3S	$>2\text{mm}$



American Opto Plus LED

C/A561E-5 G/W

0.56" Single Digit Seven Segment Display

- ❖ 0.56inch (14.22 mm) height
- ❖ Low power consumption
- ❖ RoHS Compliance
- ❖ Case mold type

LAMP HANDLING AND APPLICATION PRECAUTIONS

STORAGE

1. It is recommended to store the products in the following conditions:
 - a. Humidity: 60% RH Max
Temperature: 5°C ~ 40°C (41°F ~ 105°F)
 - b. Shelf life in sealed bag: 3 month < 40°C and 90% RH

FORMING

1. Any forming on lead pin must be done before soldering, not during or after soldering
2. Avoid applying any stress to resin in order to prevent the epoxy fracture and break on bonding wire.
3. While forming, please use a tie bar cut or equivalent to hold or bend the pin.
4. 2mm from the base of resin is the minimum distance for the place bending the lead pin
5. Avoid bending the lead pin at the same point twice or more

SOLDERING

1. No stress can be applied to lead pins when they are heated, otherwise disconnection may occur.
2. When an LED is mounted into a P.C. board, pitch spacing should be aligned carefully to avoid causing any stress to the lead wires.
3. Mounting direction (electrode direction) of SMD LED and Display should be perpendicular to direction of PCB curve
4. After soldering, don't bend the PCB

CLEANING

1. Avoid using any unspecified chemical solvent to clean LED. For example, Trichoroethylene, Chlorosen, Acetone, and Diflon S3MC.
2. Any cleaning method can only be taken under normal temperature in one minute or less if it is required
3. Special attention should be taken when using any chemicals for cleaning because some chemicals may damage the surface of epoxy.