



# American Opto Plus LED Corp.

## L354L-YYVD-H330

### 3mm Yellow LED Lamp W/ Holder

#### PACKAGE DIMENSION

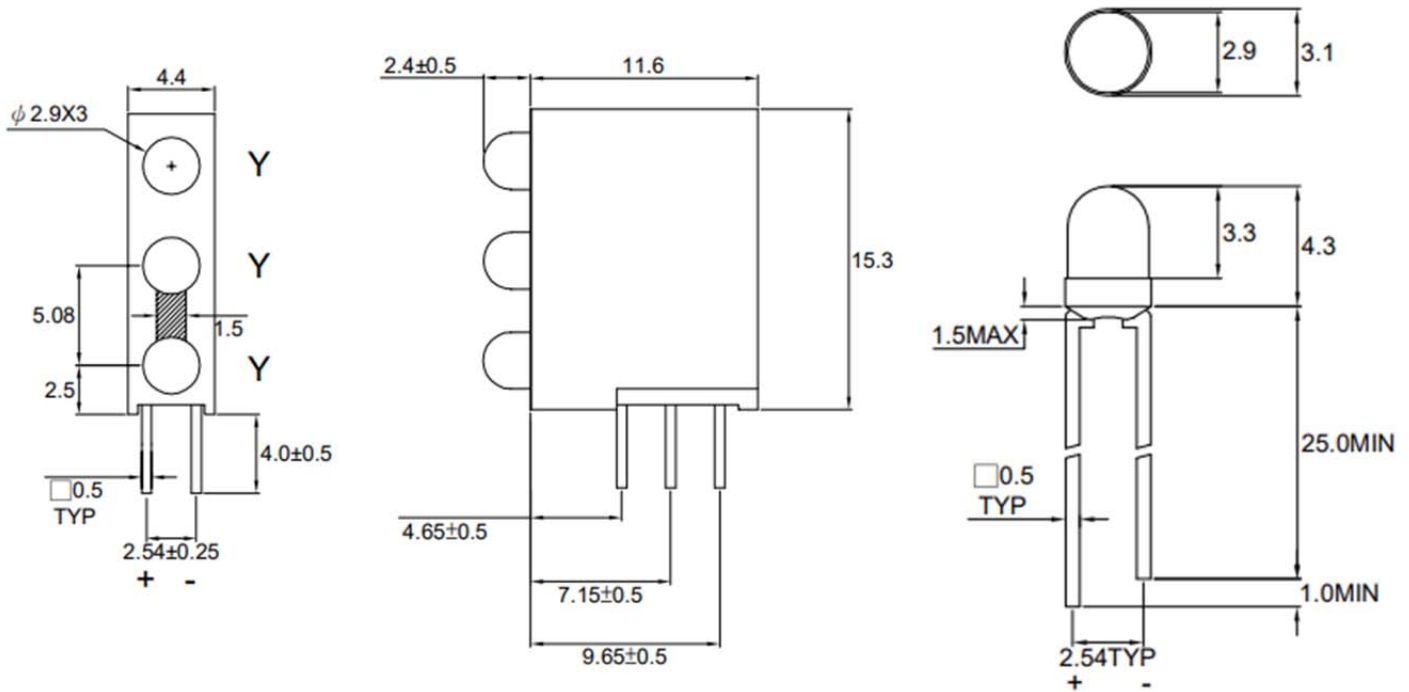

#### Notes:

1. All dimension are in millimeter tolerance is  $\pm 0.25$  mm unless otherwise noted.
2. Specifications are subject to change without notice.

Material	Color	
	Emitted	Lens
GaAsP/GaP	Yellow	Yellow Diffused



# American Opto Plus LED Corp.

## L354L-YYD-H330

3mm Yellow LED Lamp W/ Holder

### ABSOLUTE MAXIMUM RATINGS

(Ta=25°C)

Parameter	Symbol	Value	Unit
Forward Current	If	20	mA
Peak Forward Current Duty 1/10 @ 10KHz	Ifp	80	mA
Power Dissipation	Pd	60	mW
Reverse Current @ 5V	Ir	10	μA
Operating Temperature Range	Topr	-40~+85	°C
Storage Temperature Range	Tstg	-40~+100	°C

### OPTICAL-ELECTRICAL CHARACTERISTICS

(Ta=25°C)

Parameter	Symbol	Test Condition	Value			Unit
			Min	Typ	Max	
Luminous intensity	Iv	IF = 10mA	8.0	12	--	mcd
Peak Wavelength	λP	IF = 20mA	--	585	--	nm
Spectral Halfwidth	Δλ		--	35	--	nm
Forward Voltage	Vf		1.7	--	2.6	V
Viewing angle	2θ ½		--	50	--	Deg

#### Notes:

1. The forward voltage data did not including ±0.1V testing tolerance.
2. The luminous intensity data did not including ±15% testing tolerance.



# American Opto Plus LED Corp.

## L354L-YYD-H330

3mm Yellow LED Lamp W/ Holder

### ELECTRICAL-OPTICAL CHARACTERISTIC CURVES

(Ta=25°C)

Fig.1 Forward current vs. Forward Voltage

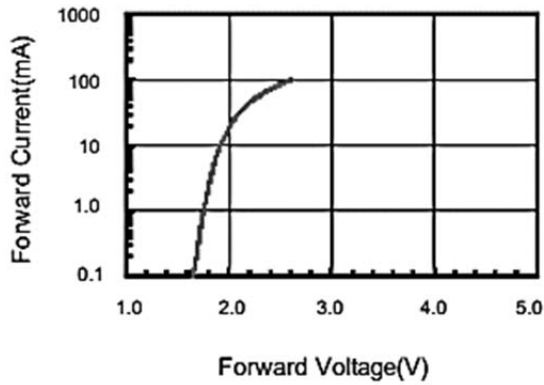

Fig.2 Relative Intensity vs. Forward Current

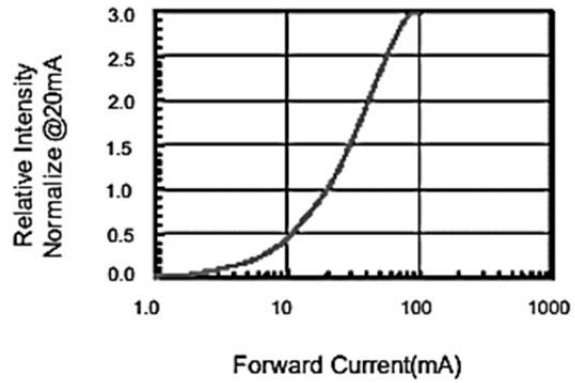

Fig.3 Forward Voltage vs. Temperature

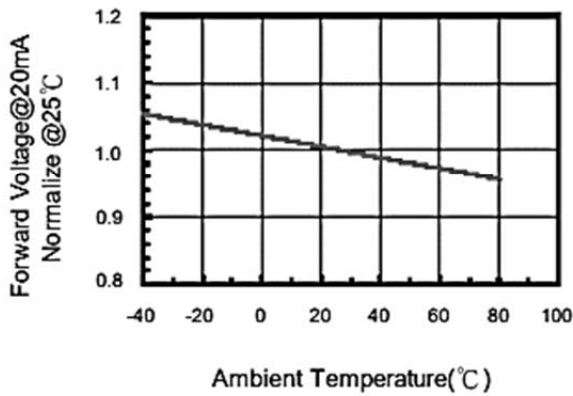

Fig.4 Relative Intensity vs. Temperature

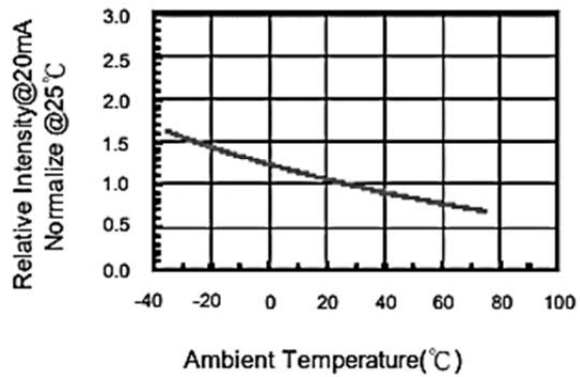
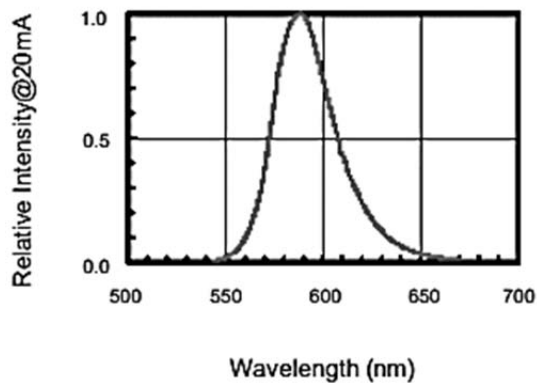

Fig.5 Relative Intensity vs. Wavelength





# American Opto Plus LED Corp.

## L354L-YYVD-H330

3mm Yellow LED Lamp W/ Holder

### RECOMMENDED SOLDERING CONDITIONS

#### 1. Iron:

Soldering Iron: 30W Max

Temperature: 350°C Max

Soldering time: 3 Seconds Max (one time only)

Distance: 2mm Min (from solder joint body)

#### 2. Wave Soldering Profile

Dip Soldering

Preheat: 120°C Max

Preheat Time: 60 Seconds Max

Ramp-up: 2°C/sec Max

Ramp-down: -5°C/sec Max

Solder Bath: 260°C Max

Dipping Time: 3 Seconds Max

Distance: 2mm Min (from solder joint body)

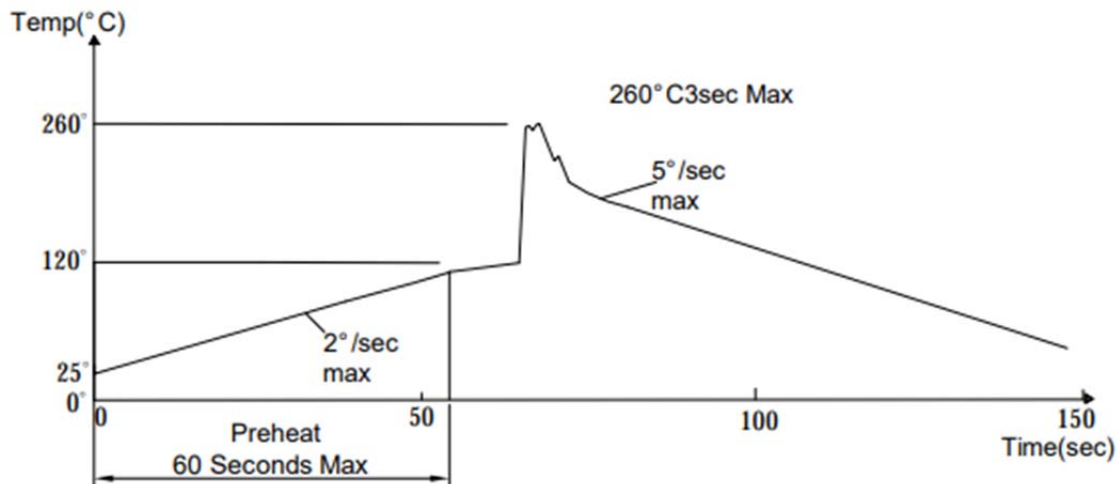



# American Opto Plus LED Corp.

## L354L-YYVD-H330

### 3mm Yellow LED Lamp W/ Holder

#### RELIABILITY TEST

Test Item	Test Condition	Description	Reference Standard
Operating Life Test	1.Under Room Temperature 2.If=20mA 3.t=1000 hrs (-24hrs, +72hrs)	This test is conducted for the purpose of determining the resistance of a part in electrical and thermal stressed.	MIL-STD-750: 1026 MIL-STD-883: 1005 JIS C 7021: B-1
High Temperature Storage Test	1.Ta=105 °C±5°C 2.t=1000 hrs (-24hrs, +72hrs)	The purpose of this is the resistance of the device which is laid under condition of high temperature for hours.	MIL-STD-883:1008 JIS C 7021: B-10
Low Temperature Storage Test	1.Ta=-40 °C±5°C 2.t=1000 hrs (-24hrs, +72hrs)	The purpose of this is the resistance of the device which is laid under condition of low temperature for hours.	JIS C 7021: B-12
High Temperature High Humidity Test	1.Ta=65°C±5°C 2.RH=90 %~95% 3.t=240hrs ±2hrs	The purpose of this test is the resistance of the device under tropical for hours.	MIL-STD-202:103B JIS C 7021: B-11
Thermal Shock Test	1.Ta=105 °C±5°C&-40 °C±5°C (10min) (10min) 2.total 10 cycles	The purpose of this is the resistance of the device to sudden extreme changes in high and low temperature.	MIL-STD-202: 107D MIL-STD-750: 1051 MIL-STD-883: 1011
Solder Resistance Test	1.T.Sol=260 °C±5°C 2.Dwell time= 10 ±1sec.	This test intended to determine the thermal characteristic resistance of the device to sudden exposures at extreme changes in temperature when soldering the lead wire.	MIL-STD-202: 210A MIL-STD-750: 2031 JIS C 7021: A-1
Solderability Test	1.T.Sol=230 °C±5°C 2.Dwell time=5 ±1sec	This test intended to see soldering well performed or not.	MIL-STD-202: 208D MIL-STD-750: 2026 MIL-STD-883: 2003 JIS C 7021: A-2