



American Opto Plus LED Corp.

L359L-EGW-H9761

3mm Bi-Color Yellow and Green LED Lamp W/ Holder

PACKAGE DIMENSION

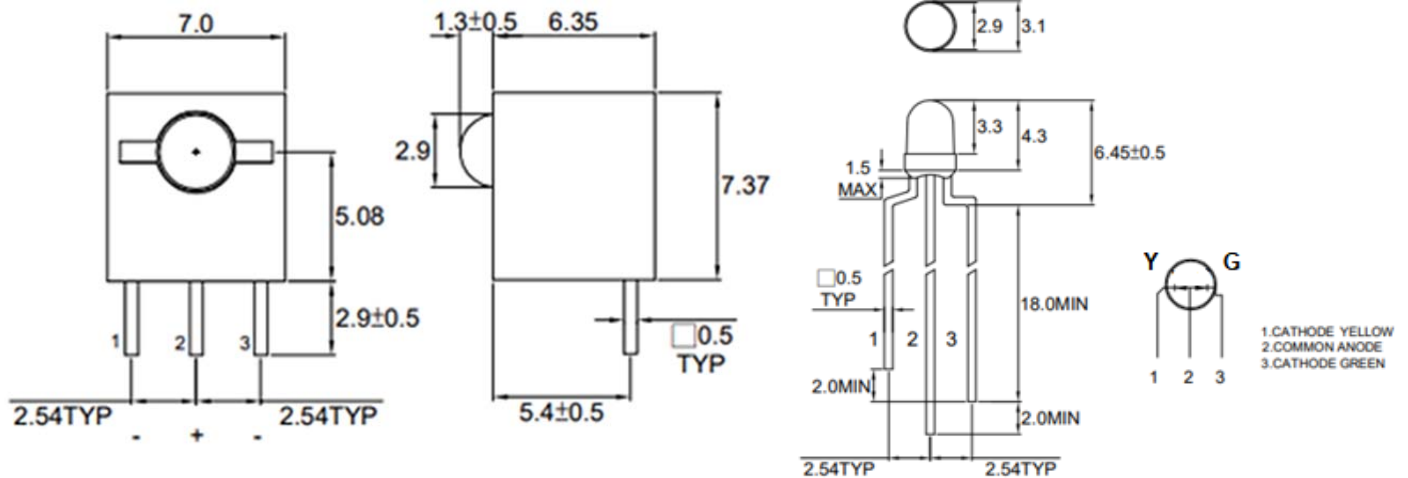

Notes:

1. All dimension are in millimeter tolerance is ± 0.25 mm unless otherwise noted
2. Specifications are subject to change without notice.

Material	Color	
	Emitted	Lens
GaAsP/GaP	Yellow	White Diffused
GaP	Green	



American Opto Plus LED Corp.

L359L-EGW-H9761

3mm Bi-Color Yellow and Green LED Lamp W/ Holder

ABSOLUTE MAXIMUM RATINGS

(Ta=25°C)

Parameter	Symbol	Value		Unit
		Y	G	
Forward Current	If	20	30	mA
Peak Forward Current Duty 1/10 @ 10KHz	Ifp	80	120	mA
Power Dissipation	Pd	60	100	mW
Reverse Current @ 5V	Ir	10	10	μA
Operating Temperature Range	Topr	-40~+85		°C
Storage Temperature Range	Tstg	-40~+100		°C

OPTICAL-ELECTRICAL CHARACTERISTICS

(Ta=25°C)

Parameter	Symbol		Test Condition	Value			Unit
				Min	Typ	Max	
Luminous intensity	Iv	Y	IF = 10mA	1.8	4.5	--	mcd
		G		1.2	2.0	--	
Peak Wavelength	λP	Y	IF = 20mA	--	585	--	nm
		G		--	565	--	
Spectral Halfwidth	Δλ	Y		--	35	--	nm
		G		--	30	--	
Forward Voltage	Vf	Y		1.7	--	2.6	V
		G		1.7	--	2.6	
Viewing angle	2θ ½		--	36	--	Deg	

Notes:

1. The forward voltage data did not including ±0.1V testing tolerance.
2. The luminous intensity data did not including ±15% testing tolerance.



American Opto Plus LED Corp.

L359L-EGW-H9761

3mm Bi-Color Yellow and Green LED Lamp W/ Holder

ELECTRICAL-OPTICAL CHARACTERISTIC CURVES (YELLOW)

(Ta=25°C)

Fig.1 Forward current vs. Forward Voltage

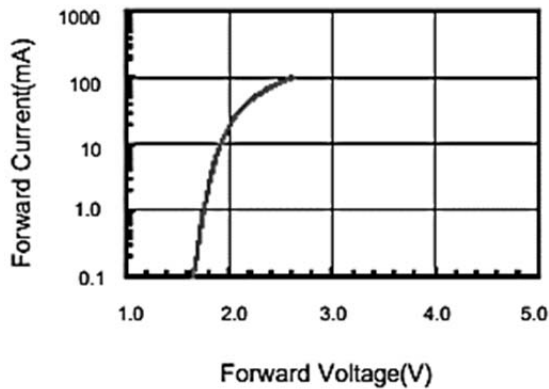

Fig.2 Relative Intensity vs. Forward Current

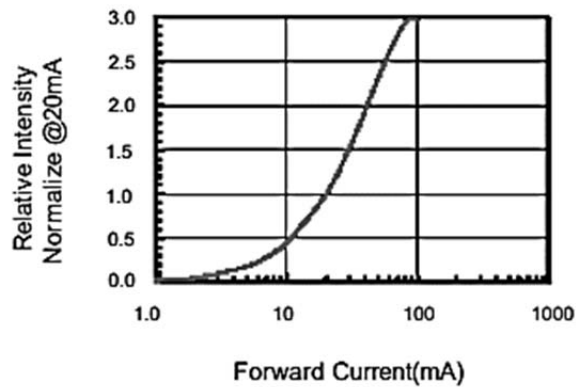

Fig.3 Forward Voltage vs. Temperature

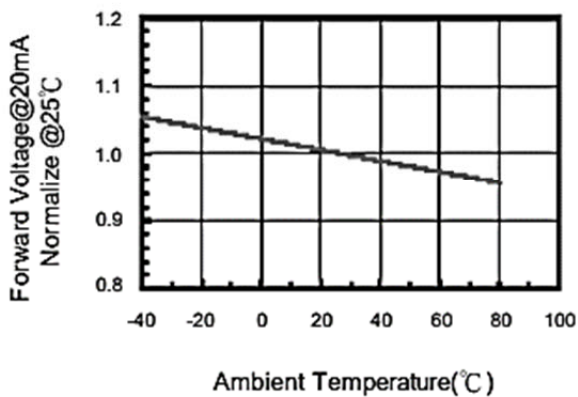

Fig.4 Relative Intensity vs. Temperature

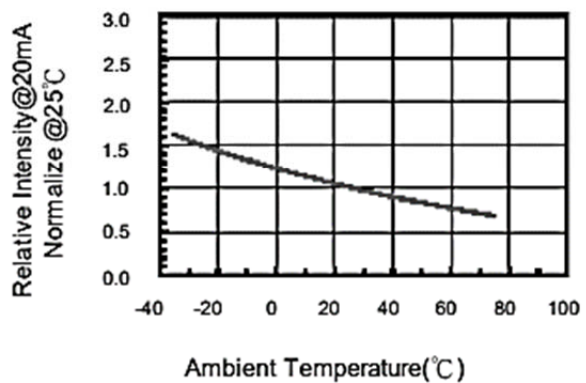
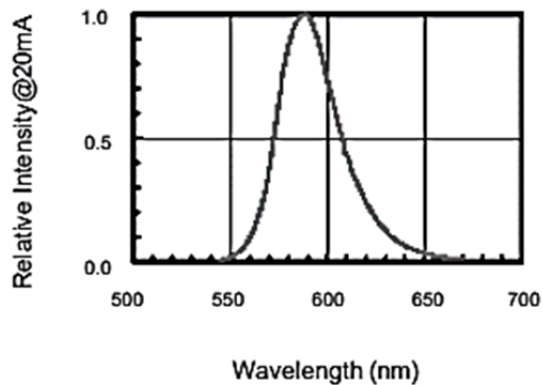

Fig.5 Relative Intensity vs. Wavelength





American Opto Plus LED Corp.

L359L-EGW-H9761

3mm Bi-Color Yellow and Green LED Lamp W/ Holder

ELECTRICAL-OPTICAL CHARACTERISTIC CURVES (GREEN)

(Ta=25°C)

Fig.1 Forward current vs. Forward Voltage

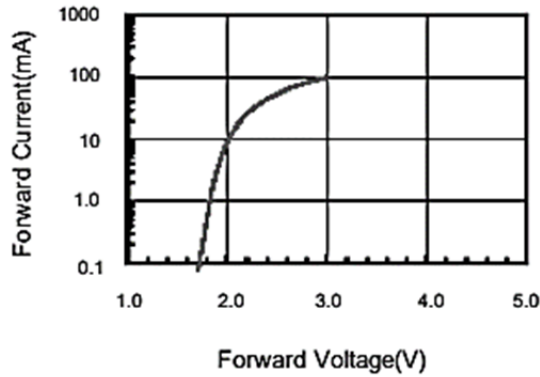

Fig.2 Relative Intensity vs. Forward Current

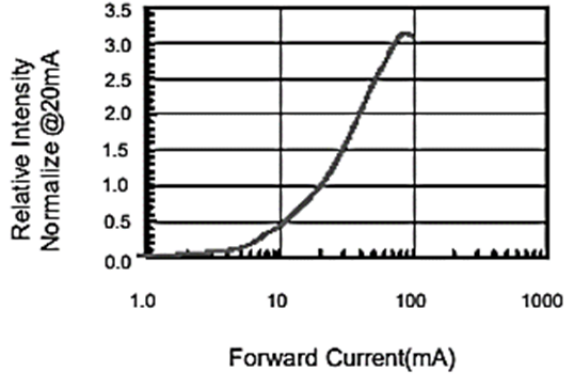

Fig.3 Forward Voltage vs. Temperature

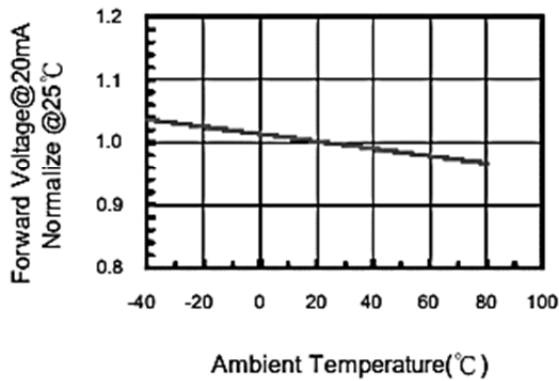

Fig.4 Relative Intensity vs. Temperature

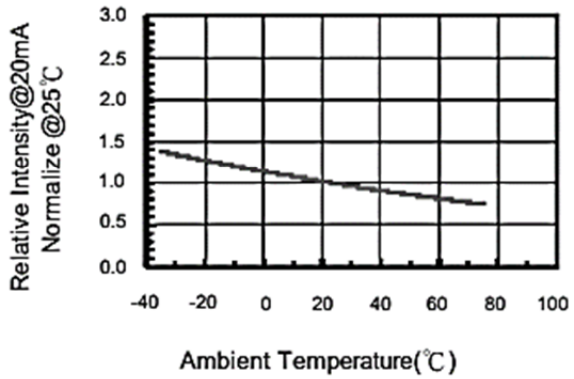
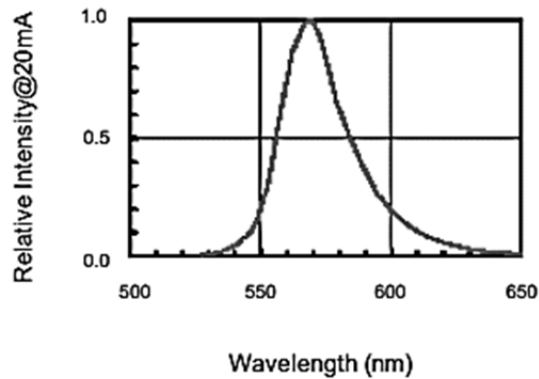

Fig.5 Relative Intensity vs. Wavelength





American Opto Plus LED Corp.

L359L-EGW-H9761

3mm Bi-Color Yellow and Green LED Lamp W/ Holder

RECOMMENDED SOLDERING CONDITIONS

1. Iron:

Soldering Iron: 30W Max

Temperature: 350°C Max

Soldering time: 3 Seconds Max (one time only)

Distance: 2mm (from solder joint body)

2. Wave Soldering Profile

Dip Soldering

Preheat: 120°C Max

Preheat Time: 60 Seconds Max

Ramp-up: 2°C/sec Max

Ramp-down: -5°C/sec Max

Solder Bath: 260°C Max

Dipping Time: 3 Seconds Max

Distance: 2mm (from solder joint body)

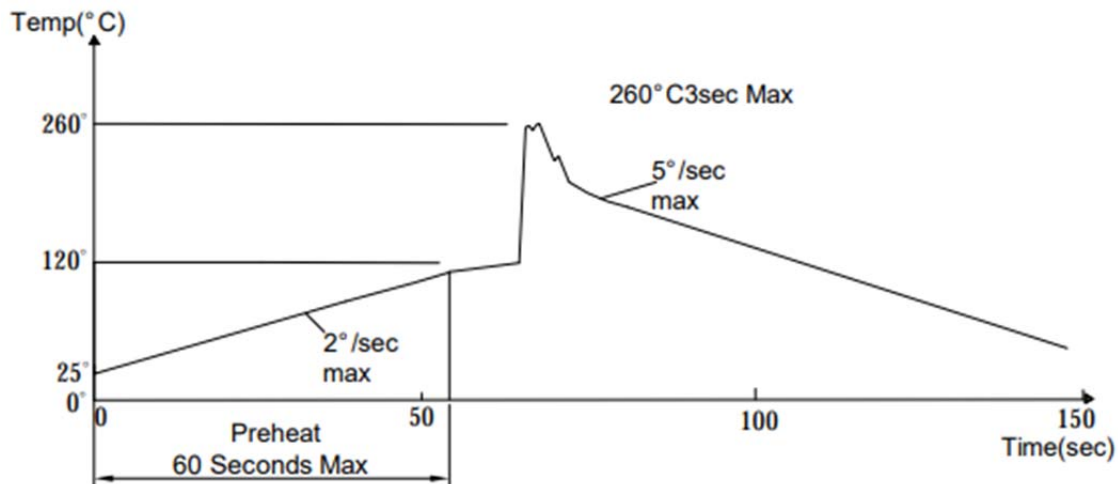



American Opto Plus LED Corp.

L359L-EGW-H9761

3mm Bi-Color Yellow and Green LED Lamp W/ Holder

RELIABILITY TEST

Test Item	Test Condition	Description	Reference Standard
Operating Life Test	1.Under Room Temperature 2.If=20mA 3.t=1000 hrs (-24hrs, +72hrs)	This test is conducted for the purpose of determining the resistance of a part in electrical and thermal stressed.	MIL-STD-750: 1026 MIL-STD-883: 1005 JIS C 7021: B-1
High Temperature Storage Test	1.Ta=105 °C±5°C 2.t=1000 hrs (-24hrs, +72hrs)	The purpose of this is the resistance of the device which is laid under condition of high temperature for hours.	MIL-STD-883:1008 JIS C 7021: B-10
Low Temperature Storage Test	1.Ta=-40 °C±5°C 2.t=1000 hrs (-24hrs, +72hrs)	The purpose of this is the resistance of the device which is laid under condition of low temperature for hours.	JIS C 7021: B-12
High Temperature High Humidity Test	1.Ta=65°C±5°C 2.RH=90 %~95% 3.t=240hrs ±2hrs	The purpose of this test is the resistance of the device under tropical for hours.	MIL-STD-202:103B JIS C 7021: B-11
Thermal Shock Test	1.Ta=105 °C±5°C&-40 °C±5°C (10min) (10min) 2.total 10 cycles	The purpose of this is the resistance of the device to sudden extreme changes in high and low temperature.	MIL-STD-202: 107D MIL-STD-750: 1051 MIL-STD-883: 1011
Solder Resistance Test	1.T.Sol=260 °C±5°C 2.Dwell time= 10 ±1sec.	This test intended to determine the thermal characteristic resistance of the device to sudden exposures at extreme changes in temperature when soldering the lead wire.	MIL-STD-202: 210A MIL-STD-750: 2031 JIS C 7021: A-1
Solderability Test	1.T.Sol=230 °C±5°C 2.Dwell time=5 ±1sec	This test intended to see soldering well performed or not.	MIL-STD-202: 208D MIL-STD-750: 2026 MIL-STD-883: 2003 JIS C 7021: A-2