



American Opto Plus LED Corp.
0.56" SMD Type LED Display
SMC/A561A G/W

● **EDIT HISTORY**

Version A: Apr. 23, 2009

New color data sheet.

Version B: Mar. 17, 2010

Change mechanical dimensions.



American Opto Plus LED Corp.

0.56" SMD Type LED Display

SMC/A561A G/W

● FEATURES

- 0.56 inch (14.2 mm) Digit Height.
- Low current operation.
- SMD type.
- Gray face, White segment.
- RoHS compliant, Pb Free.

● DESCRIPTION

The SMC/A561A G/W is a 0.56 inch (14.2 mm) height single 7-segment display. This device utilizes Amber LED chip which are made from GaAsP on a transparent GaP substrate. The display has Gray face, White segment.

● DEVICE

PART NO	DESCRIPTION
Amber	Common Cathode / Anode
SMC/A561A G/W	

RoHS Compliance



Pb free.





American Opto Plus LED Corp.

0.56" SMD Type LED Display

SMC/A561A G/W

● MECHANICAL DIMENSIONS

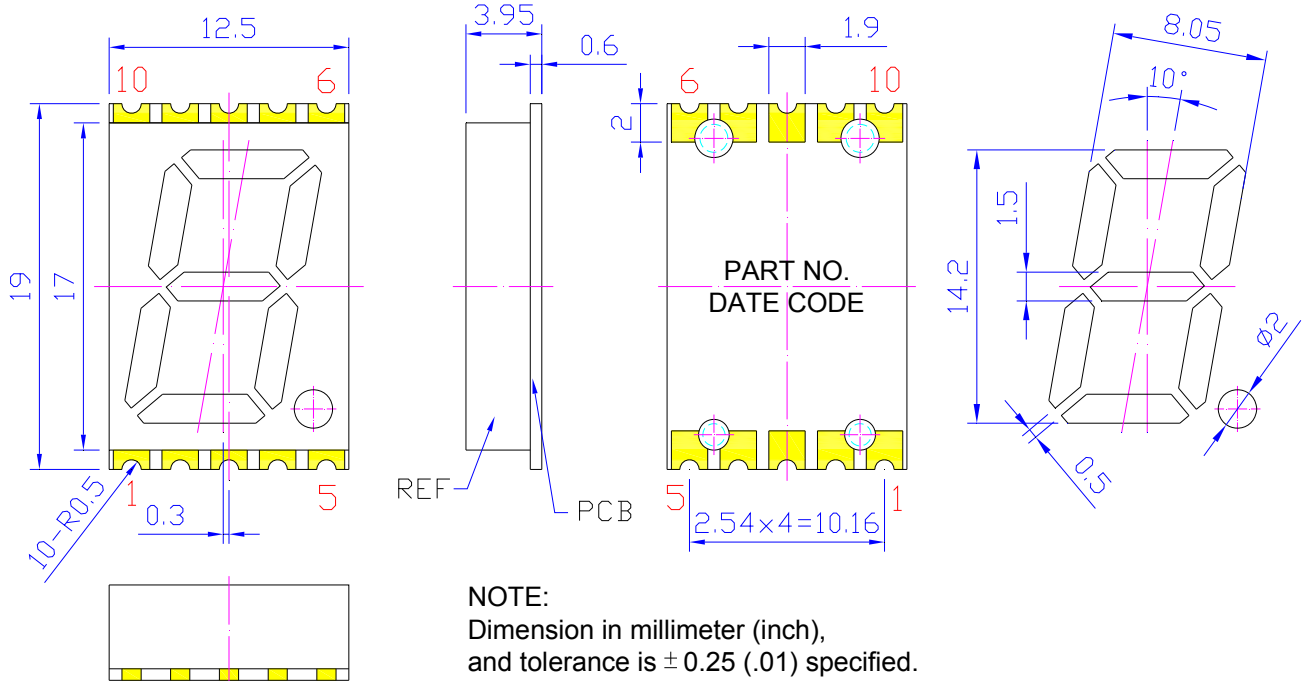

● TYPICAL INTERNAL EQUIVALENT CIRCUIT

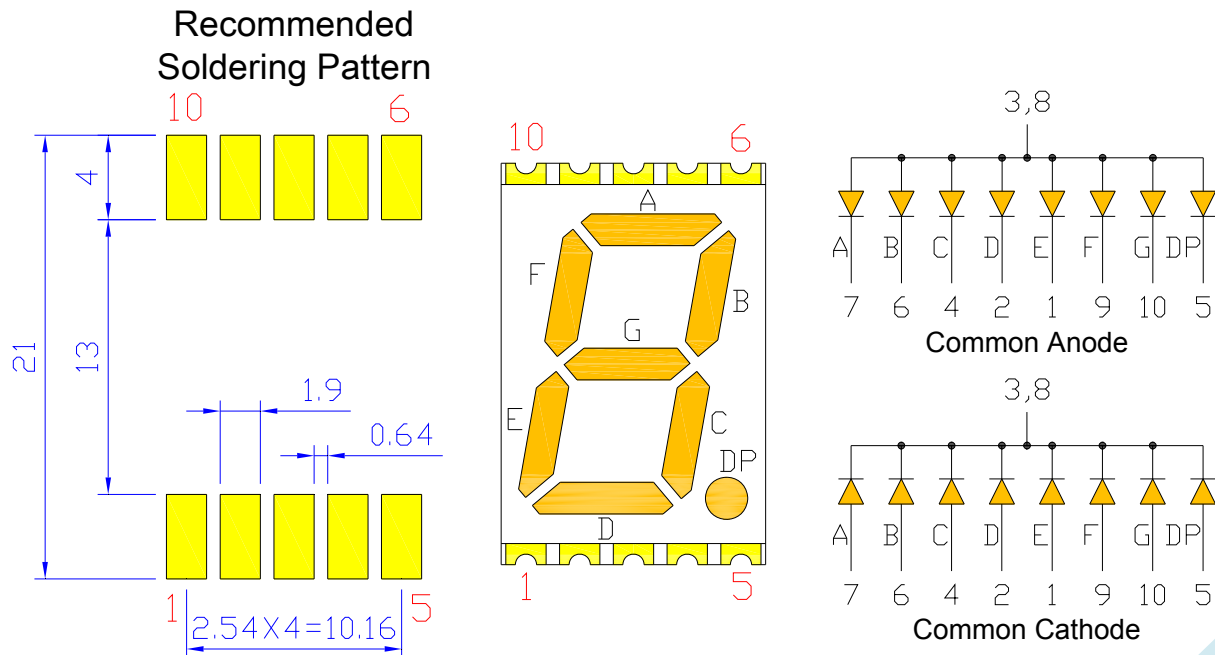



American Opto Plus LED Corp.
0.56" SMD Type LED Display
SMC/A561A G/W

● **A: AMBER (GaAsP/GaP)**

ABSOLUTE MAXIMUM RATING AT Ta=25°C

Parameter	Symbol	Amber	Unit
Power dissipation per dice	P _{AD}	70	mW
Derating liner from 25°C per dice	-	0.28	mA / °C
Continuous forward current per dice	I _{AF}	25	mA
Peak current per dice (duty cycle 1/10, 1kHz)	I _{PF}	90	mA
Reverse voltage per dice	V _R	5	V
Operating temperature	T _{OPR}	-40 to +105	°C
Storage temperature	T _{STG}	-40 to +105	°C

ELECTRICAL - OPTICAL CHARACTERISTICS AT Ta=25°C

Characteristic	Symbol	Condition	Min.	Type.	Max.	Unit
Forward voltage per dice	V _F	I _F =20mA	-	2.0	2.6	V
Reverse current per dice	I _R	V _R =5V	-	-	10	μA
Peak wavelength per dice	λ _P	I _F =20mA	-	610	-	nm
Dominant wavelength per dice	λ _D	I _F =20mA	-	606	-	nm
Luminous intensity per dice	I _V	I _F =20mA	6	-	-	mcd
Spectral radiation bandwidth per dice	Δλ	I _F =20mA	-	35	-	nm



American Opto Plus LED Corp.

0.56" SMD Type LED Display

SMC/A561A G/W

● A: AMBER (GaAsP/GaP) CURVE

Typical Electro-optical Characteristic Curves
(25 °C Free Air Temperature Unless Otherwise Specified)

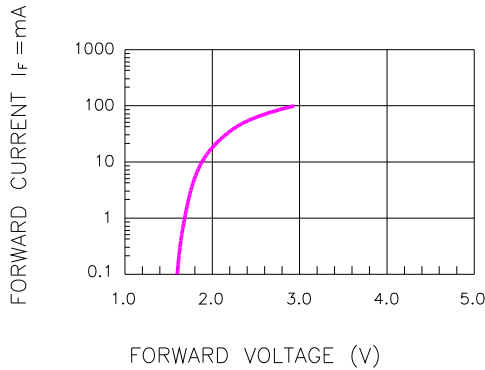

Fig.1 FORWARD CURRENT VS. FORWARD VOLTAGE

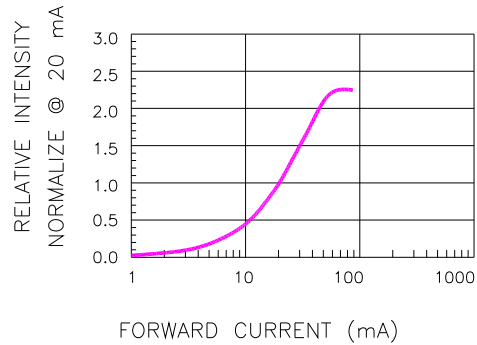

Fig.2 RELATIVE INTENSITY VS. FORWARD CURRENT

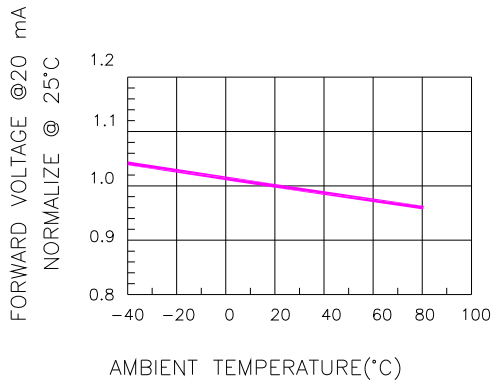

Fig.3 FORWARD VOLTAGE VS. TEMPERATURE

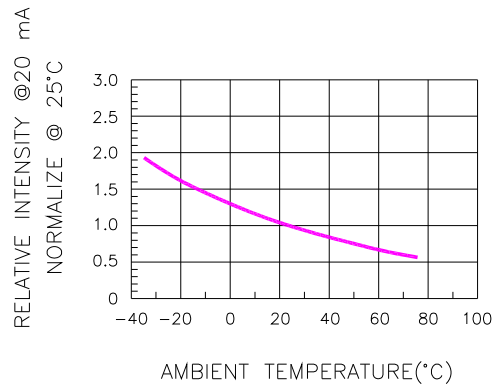

Fig.4 RELATIVE INTENSITY VS. TEMPERATURE

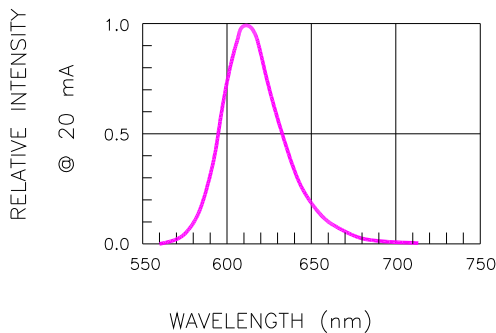

Fig.5 RELATIVE INTENSITY VS. WAVELENGTH

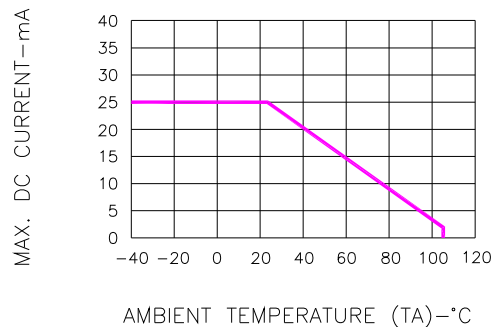

Fig.6 MAX. ALLOWABLE DC CURRENT VS. AMBIENT TEMPERATURE



American Opto Plus LED Corp.

0.56" SMD Type LED Display

SMC/A561A G/W

● SMT REFLOW SOLDERING INSTRUCTIONS

SMT Soldering Profile

Pb free reflow soldering Profile

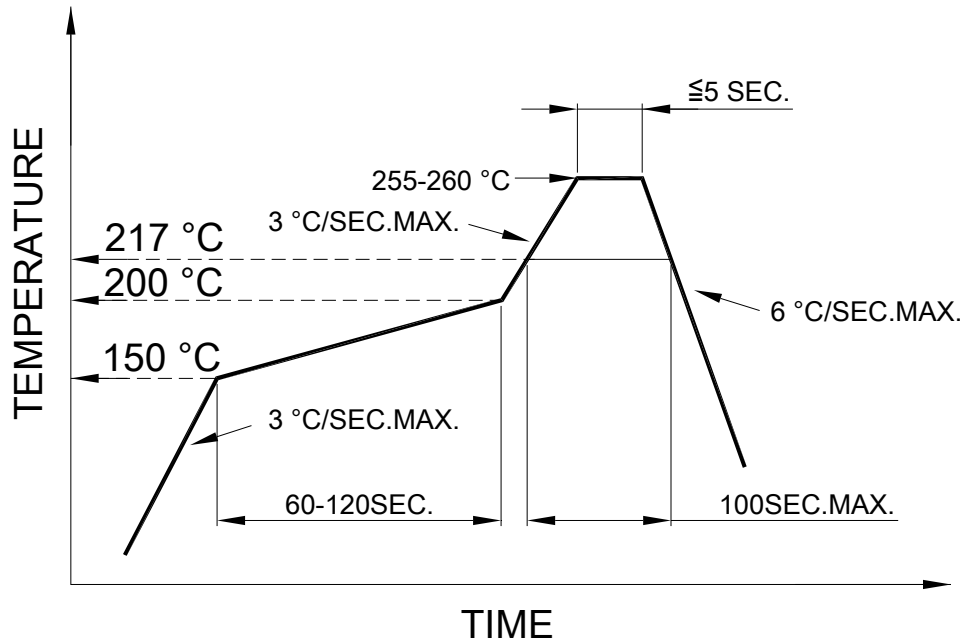

● SOLDERING IRON

Basic spec is ≤ 4 sec when 260°C. If temperature is higher, time should be shorter (+10°C → 1 sec). Power dissipation of Iron should be smaller than 15W, and temperature should be controllable. Surface temperature of the device should be under 230°C.

● REWORK

- Customer must finish rework within 5 sec. under 260°C.
- The head of soldering iron cannot touch copper foil.



American Opto Plus LED Corp.

0.56" SMD Type LED Display

SMC/A561A G/W

● REEL DIMENSIONS

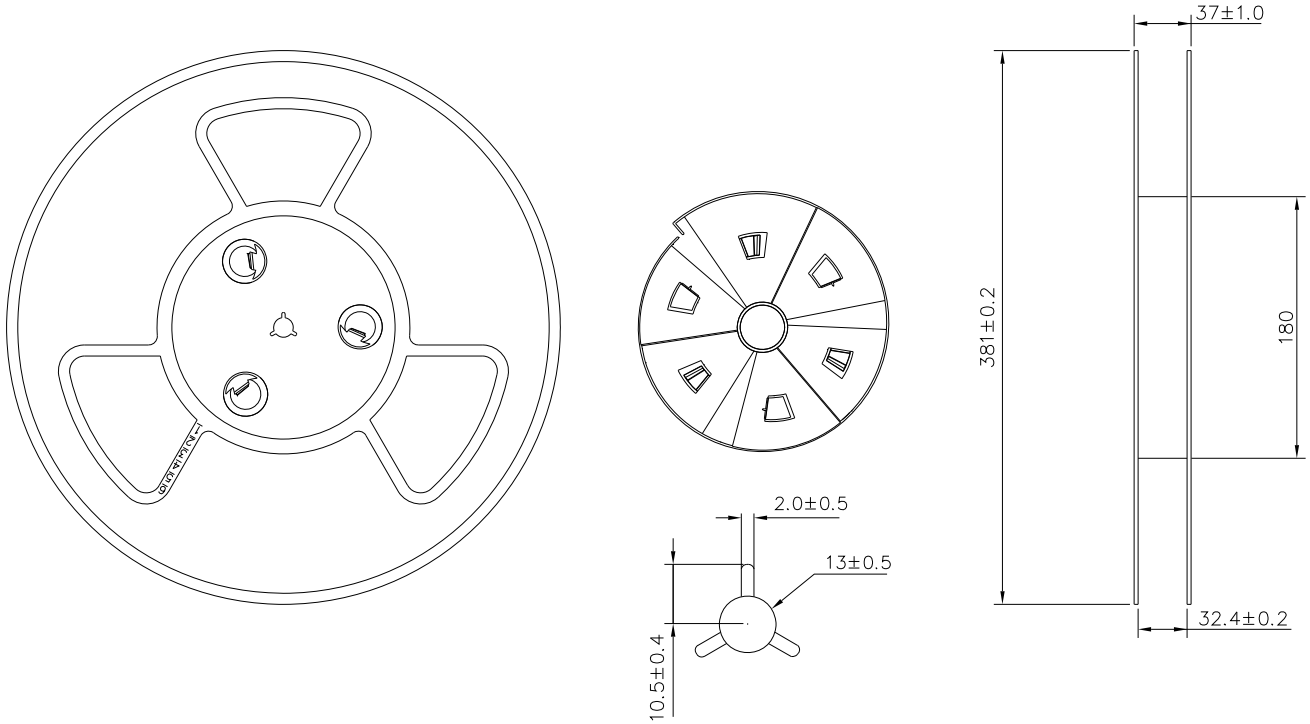

● PACKING & LABEL SPECIFICATIONS

